

SOFTWARE

KR C...

Operator Control

KUKA System Software (KSS)

Release 4.1

© Copyright **KUKA Roboter GmbH**

This documentation or excerpts therefrom may not be reproduced or disclosed to third parties without the express permission of the publishers. Other functions not described in this documentation may be operable in the controller. The user has no claim to these functions, however, in the case of a replacement or service work.

We have checked the content of this documentation for conformity with the hardware and software described. Nevertheless, discrepancies cannot be precluded, for which reason we are not able to guarantee total conformity. The information in this documentation is checked on a regular basis, however, and necessary corrections will be incorporated in subsequent editions.

Subject to technical alterations without an effect on the function.

PD Interleaf

Contents

1	Running up / shutting down the controller	9
1.1	General	9
1.2	Operator control elements on the control cabinet “KR C1”	10
1.3	Operator control elements on the control cabinet “KR C2”	11
1.4	Operator control elements on the control cabinet “KR C3”	12
1.5	Running up the controller	13
1.6	Shutting down the controller	14
1.7	Controller response when switched back on	15
1.7.1	Cold start	15
1.7.2	Warmstart	15
1.7.2.1	Hardware requirements	16
1.7.2.2	Power failure with the system running	16
1.7.2.3	Power failure during a cold start	17
1.7.2.4	Power failure during a restart	17
1.7.3	Setting external power supply and user outputs	18
1.8	Battery charge monitoring	19
1.8.1	KR C1 response	19
1.8.2	KR C2 response	20
1.9	Virus protection	22
2	The KUKA Control Panel KCP	29
2.1	General	29
2.2	Operator control elements of the KCP	30
2.3	The rear of the KCP	37
2.4	Graphical user interface (GUI)	38
2.4.1	Settings for brightness and contrast	38
2.4.2	Function keys	38
2.4.3	Input/output windows	39
2.4.4	System status	41
2.4.5	Messages	42
2.4.6	Status bar	43
2.4.7	Toggling to the Windows interface	45
2.4.7.1	Alt-Tab	45
2.4.7.2	Alt-Escape	46
2.4.7.3	CTRL-Escape	46
2.4.8	Windows mouse emulation using keys	47
3	Coordinate systems	49
3.1	General	49
3.2	Joint coordinate system	50
3.3	WORLD coordinate system	51
3.4	BASE coordinate system	52

3.5	TOOL coordinate system	53
4	Manual traversing of the robot	55
4.1	General	55
4.2	Selecting the traversing mode	57
4.3	Selecting the kinematic system	58
4.4	Selecting the coordinate system	59
4.5	Jog override (manual traversing velocity)	61
4.6	Moving the robot with the Space Mouse	62
4.6.1	General	62
4.6.2	Mouse position	63
4.6.3	Degrees of freedom of the Space Mouse (Mouse configuration)	66
4.6.3.1	Motion of the main axes	67
4.6.3.2	Motion of the main axes	67
4.6.3.3	Unlimited functionality	68
4.6.4	Dominant axis of the Space Mouse (Mouse configuration)	69
4.6.4.1	Dominant axis activated	70
4.6.4.2	Dominant axis not activated	70
4.7	Moving the robot with the traversing keys	71
4.7.1	Joint coordinate system	71
4.7.2	Coordinate systems TOOL, BASE, WORLD	72
4.7.3	Incremental manual traversing	73
5	Navigator	75
5.1	General	75
5.2	Graphical user interface	76
5.2.1	Fundamentals	76
5.2.2	Header	78
5.2.3	Directory structure, attributes display, selection list	79
5.2.3.1	Directory structure	79
5.2.3.2	Attributes display	80
5.2.3.3	Selection list	82
5.2.4	Directory and file list	84
5.2.4.1	Pop-up menu	85
5.2.4.2	Additional information	86
5.2.4.3	Windows 95 and kernel system attributes	87
5.2.5	Status line	88
5.2.6	Error display	89
5.2.6.1	Error list	89
5.2.6.2	Edit	93
5.2.6.3	Data list	93
5.2.6.4	Delete	93
5.3	“File” menu	94
5.3.1	New	95
5.3.1.1	Create folder	95
5.3.1.2	Create module	96
5.3.2	Edit	98
5.3.2.1	Open a subdirectory	98
5.3.2.2	Load file into the editor	98
5.3.2.3	Edit a data list	99

5.3.2.4	Open an error list	99
5.3.3	Print	100
5.3.3.1	Current selection	100
5.3.3.2	Log book	101
5.3.4	Archive	102
5.3.4.1	All	103
5.3.4.2	Applications	103
5.3.4.3	Machine data	103
5.3.4.4	Configure	104
5.3.4.5	Log Data	104
5.3.4.6	Current selection	104
5.3.5	Restore	105
5.3.5.1	All	106
5.3.5.2	Applications	106
5.3.5.3	Machine data	106
5.3.5.4	Configure	107
5.3.5.5	Current selection	107
5.3.6	Rename	109
5.3.7	Format floppy disk	110
5.3.8	Attributes	111
5.3.9	Filter	111
5.4	“Edit” menu	112
5.4.1	Mark all	113
5.4.2	Copy	113
5.4.3	Paste	113
5.4.4	Cut	114
5.4.5	Delete	114
5.4.6	Duplicate	115
5.4.7	Select	116
5.4.7.1	Without parameters	116
5.4.7.2	With parameters	117
5.4.8	Cancel program	117
5.4.9	Reset program	118
5.5	“Monitor” menu	119
5.6	Appendix	120
5.6.1	Keyboard assignment of the Navigator	120
5.6.2	Default settings at User and Expert levels	122
6	Executing, stopping and resetting a program	125
6.1	Selecting and opening a program	125
6.1.1	Symbols in the program window	126
6.1.2	Program status line	128
6.2	Setting work velocity (program override)	129
6.3	Stop reactions	130
6.3.1	Ramp-down braking	130
6.3.2	Path-maintaining Emergency Stop	130
6.3.3	Maximum braking	130
6.3.4	Short-circuit braking (dynamic braking)	131
6.3.5	Warning and safety instructions	131
6.4	Manual program execution (jog mode)	132
6.4.1	Program run mode “Go”, “Single Step” or “I-Step”	132

6.4.2	BCO run	133
6.4.3	Executing individual program lines	135
6.4.4	Program start backwards	136
6.4.5	Stopping program execution	137
6.4.6	Resetting a program (Reset)	137
6.4.7	Continuing a program	138
6.5	Automatic program execution	139
6.5.1	BCO run	139
6.5.2	Stopping program execution	139
6.5.3	Continuing a program	139
6.6	Deselecting a program	141
7	Monitor	143
7.1	Inputs/outputs	143
7.1.1	Digital inputs	144
7.1.2	Digital outputs	146
7.1.3	Analog Outputs	148
7.1.4	Gripper	150
7.1.5	Automatic External	151
7.1.5.1	Inputs	151
7.1.5.2	Outputs	152
7.2	Rob. Position	156
7.2.1	Cartesian	156
7.2.2	Joint	157
7.2.3	Incremental	158
7.2.4	Master/slave display	159
7.3	Variable	160
7.3.1	Single	160
7.3.2	Overview	162
7.3.2.1	Monitor	162
7.3.2.2	Configure	163
7.3.2.3	Display	163
7.3.3	Cyclic Flags	164
7.3.4	Flags	165
7.3.5	Counter	166
7.3.6	Timer	167
7.4	Diagnosis	168
7.4.1	Oscilloscope	169
7.4.2	Log book	169
7.4.2.1	Display	169
7.4.2.2	Configuration	173
7.4.3	CROSS Log book	174
7.4.4	Caller Stack	175
7.4.5	Interrupts	177
7.4.6	Safety circuit	178
7.4.7	Web Diagnosis	178
7.5	Windows	179
7.6	Help	180
7.6.1	Online help	180
7.6.1.1	Message window	180
7.6.1.2	Log book	181

7.6.1.3	Inline forms	182
7.6.1.4	Error display	183
7.6.2	Online Help – Contents/Index	184
7.6.3	Info	189
8	Menu structure	193
8.1	General	193
8.2	File	195
8.3	Program... ..	199
8.3.1	“Program” in the navigator	199
8.3.2	“Program” at programming level	201
8.3.3	“Program” in the editor	203
8.4	Configure	205
8.5	Monitor	209
8.6	Setup	213
8.7	Commands	218
8.8	Technology	221
8.9	Help	224



1 Running up / shutting down the controller

1.1 General

The KR C... control cabinet contains the power and control electronics for the robot. Apart from the main switch, all the operator control elements of the controller are located on the KCP (KUKA Control Panel) hand programming unit.



Running up the controller presupposes that the initial start-up procedure has been carried out correctly and that the system is set up ready for production.

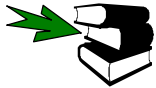

The meaning of the symbols, icons and particular font conventions is explained in the chapter **[About this Documentation]**.



The KR C1 or KR C2 control cabinet door may only be opened by a skilled and appropriately trained electrician for the purpose of service work. On completion of the work, the control cabinet door must be carefully closed again to avoid dirt deposits and to prevent unauthorized access!



The cabinet door of the KR C1 or KR C2 must be closed again immediately after service work, otherwise the cooling effect of the internal airflow is lost. **Failure to do so can cause the controller to overheat and fail.**

1.2 Operator control elements on the control cabinet “KR C1”

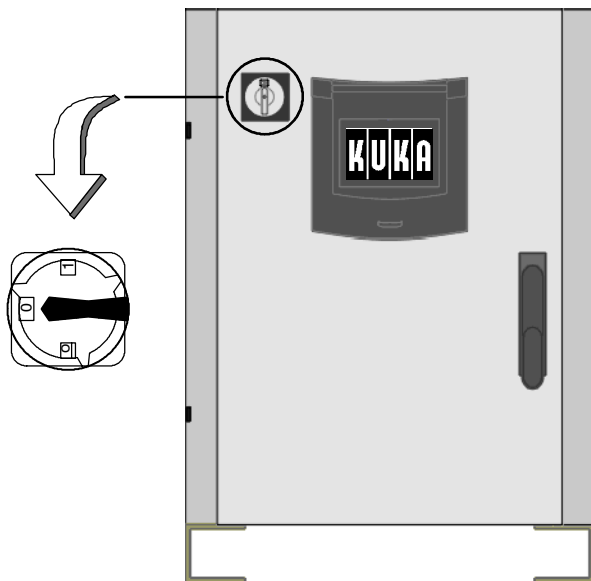

Main switch

The robot system and controller are switched on and off with the main switch.

A padlock fitted to the main switch can be used to prevent it reliably from being switched on accidentally (e.g. during maintenance work on the robot system).

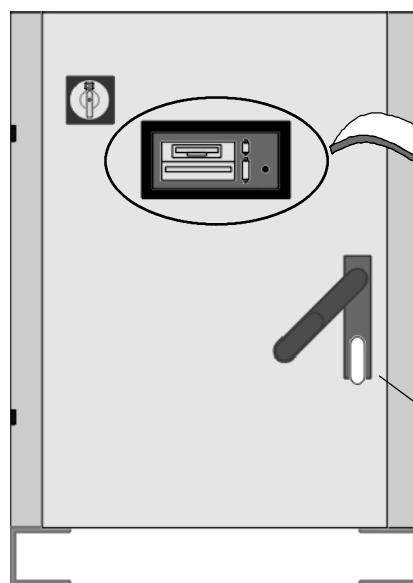

Computer drives and ports

A flap gives access to a floppy disk drive and a CD-ROM drive, the ports COM1 and LPT1 and the status LED (Control ON).

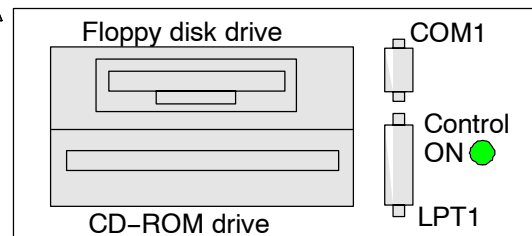

Cabinet lock

The cabinet lock is protected by a cover, which also serves as the door handle.

It is also possible to connect a standard serial mouse to the computer system's COM1 port. This can even be connected and disconnected during operation without having to reboot the system. For this reason, COM1 is automatically used by the mouse driver.



Applications and functions that access the COM1 port must be reconfigured to a different COM port.

The temporary connection of a keyboard to the corresponding DIN or PS/2 port is also possible.



The drives flap on the control cabinet door may only be opened for the purpose of using the drives in order to prevent dust and moisture from entering the drives. Please make sure that this flap remains closed and latched tight at all other times.

1.3 Operator control elements on the control cabinet “KR C2”

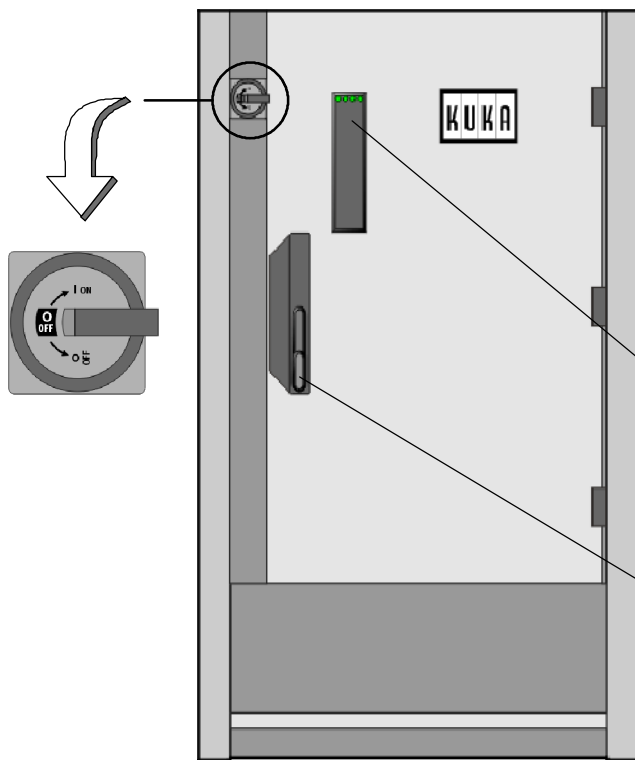

Main switch

The robot system and controller are switched on and off with the main switch. A padlock fitted to the main switch can be used to prevent it reliably from being switched on accidentally (e.g. during maintenance work on the robot system).

Options

If the control cabinet is equipped with extra options, their functional status is indicated by the LEDs.

Cabinet lock

The cabinet lock is protected by a cover, which also serves as the door handle.

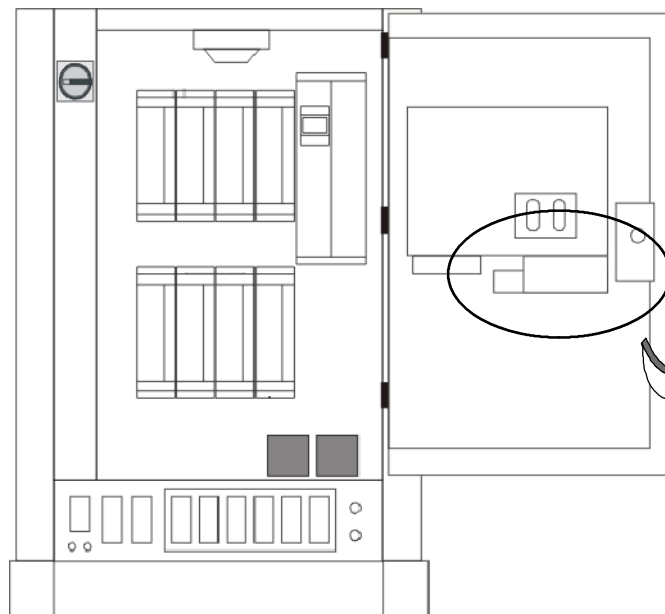

Computer drives

With the cabinet door open, a CD-ROM drive and a floppy disk drive are accessible.

CD-ROM drive



Floppy disk drive

It is also possible to connect a standard serial mouse to the computer system's COM1 port. This can even be connected and disconnected during operation without having to reboot the system. For this reason, COM1 is automatically used by the mouse driver.



Applications and functions that access the COM1 port must be reconfigured to a different COM port.

The temporary connection of a keyboard to the corresponding DIN or PS/2 port is also possible.



In order to prevent dust and moisture from entering the control cabinet, the door may only be opened for short periods of time. Make sure that this door is properly closed at all other times.

1.4 Operator control elements on the control cabinet “KR C3”

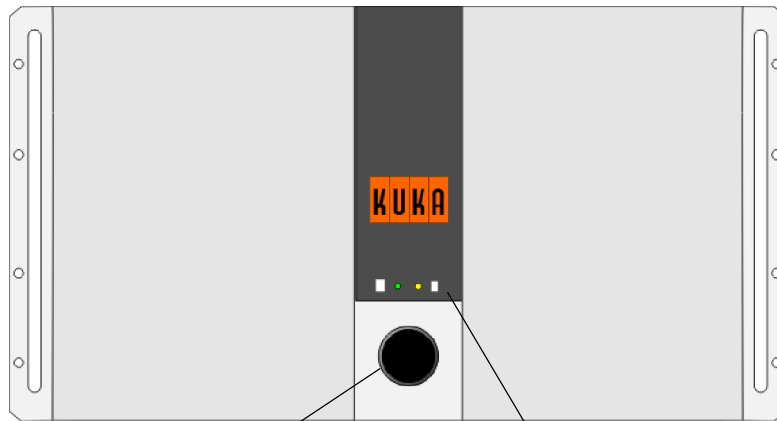

KCP connection

The cable of the KCP (KUKA Control Panel) is connected to this socket.

Status indication

The first LED shows whether or not the system is switched on. The second indicates that the computer unit hard drive is being accessed.

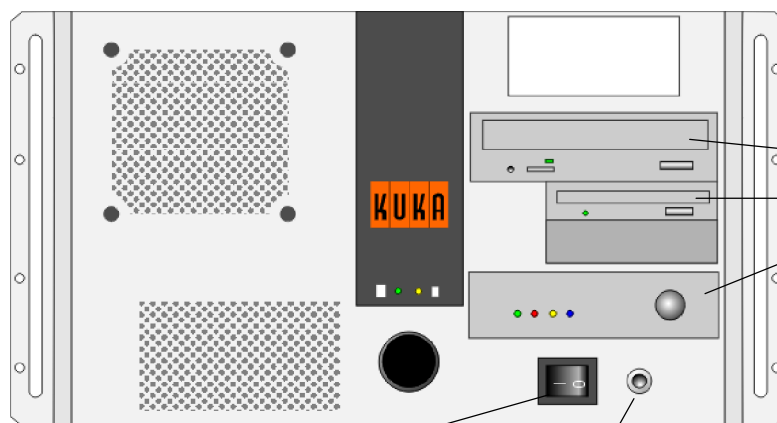

On/off switch

The entire robot system is switched on and off with this switch.

Reset

This button is used to reset the computer (warm start) without having to switch the system off and back on again.

CD-ROM drive

Floppy disk drive

IUPS



Both doors on the control module must be kept shut in order to keep dirt out.

1.5 Running up the controller

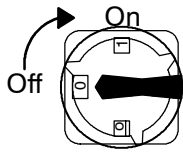

After the robot system has been switched on using the main switch on the control cabinet, the computer begins to run up (load) the operating system and the control software. This loading process lasts several minutes. Progress is displayed on the KCP display by means of a progress indicator bar.

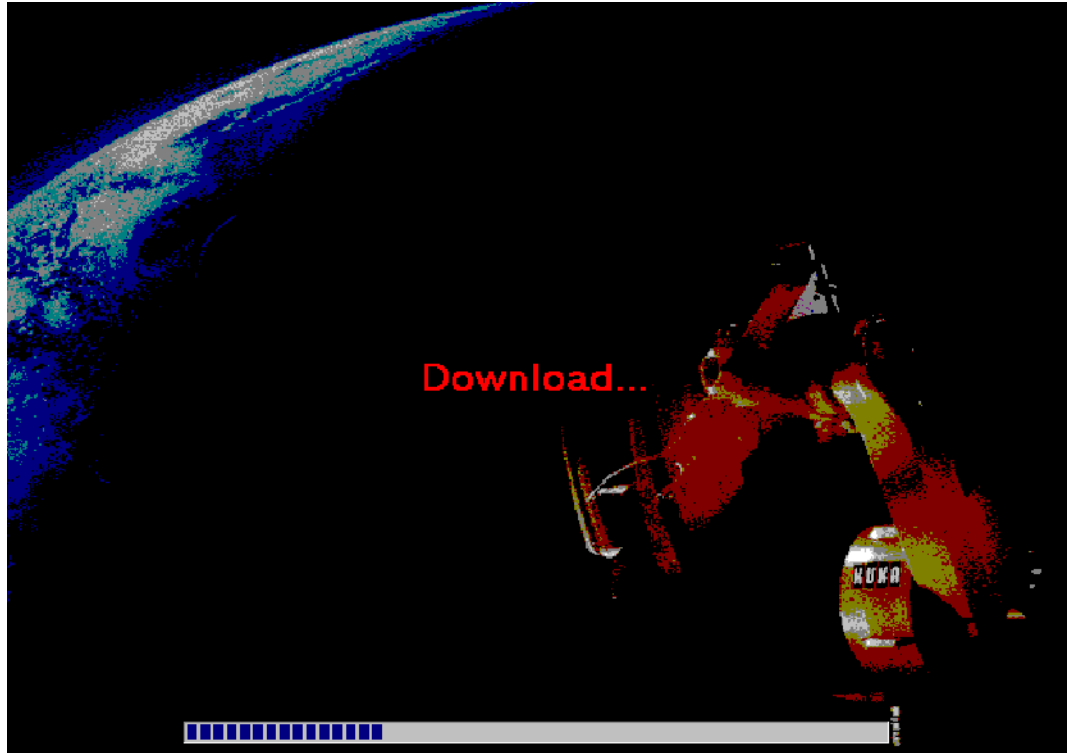

The display then shows the main menu for program creation, selection and execution:

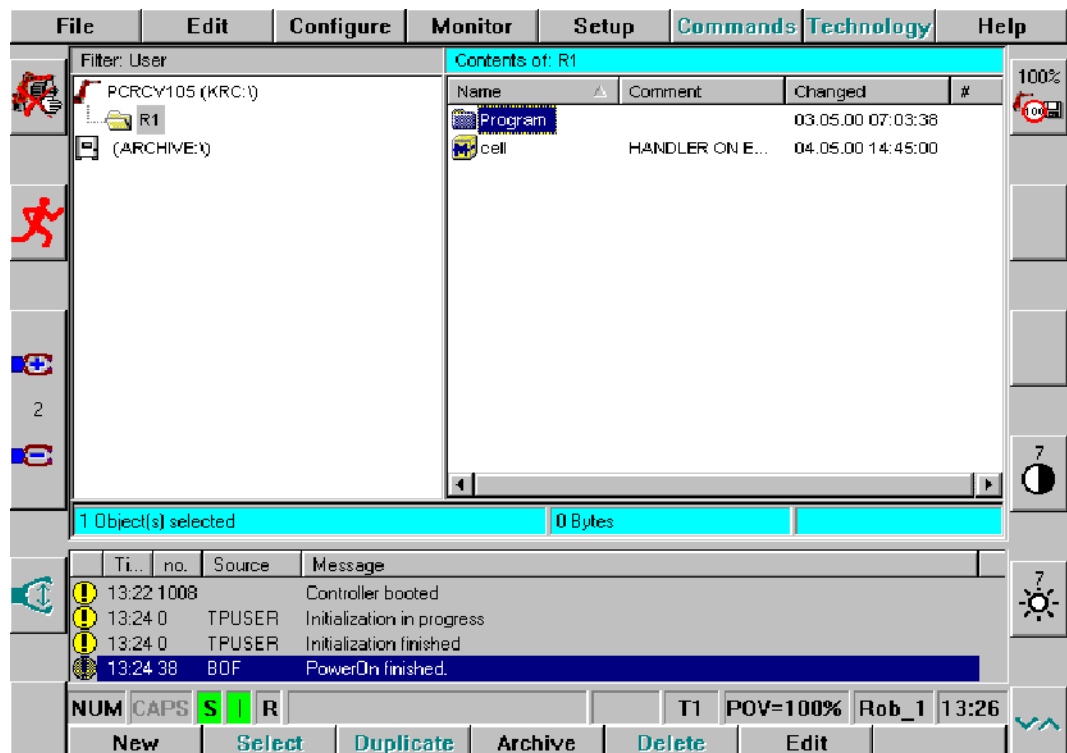



If the machine data loaded do not match the robot type, a corresponding error message is generated when the controller is booted. The robot must not be moved in this case.



The robot can be moved manually and programs started only if there is no EMERGENCY STOP situation and – in the “Automatic” mode – the drives are switched on.

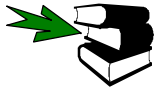

Information on the operator control elements “EMERGENCY STOP button” and “Drives ON” may be found in the chapter **[The KUKA Control Panel KCP]**, in the section **[Operator control elements of the KCP]**.

1.6 Shutting down the controller

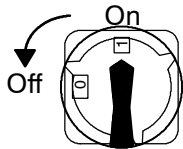

After the robot system has been switched off using the main switch on the control cabinet, the controller shuts down its own software and the operating system. Certain data are automatically saved in this procedure (Power OFF function). This only happens, however, if the controller was correctly and completely run up beforehand.

1.7 Controller response when switched back on

The controller offers two system boot variants:

- Cold start
- Warm restart

1.7.1 Cold start

The cold start behaves in the same way as the earlier control software versions. No program is selected when the system has booted and the user outputs are set to "FALSE".



In "Automatic External" mode, the program "CELL" is automatically selected and executed.

1.7.2 Warmstart

A warm start is intended to keep production downtimes to a minimum in the event of a power failure. Once the system has booted, the position reached in the program immediately before the power failure is restored. The field buses are reset (even in the event of a fault). Outputs that were set at the time the system was switched off are set again when the system reboots. The processing of the program can then be resumed from the point that had been reached in the program. In most cases it is no longer necessary to move the cell free.

This variant is activated by default.



Before restarting the system, you must decide whether it is still sensible to resume program execution given that the outputs will be reset or restored. It would not be sensible to continue the program, for example, if the robot had lost the component.

From the point of view of the operator, the following things happen in the event of a power failure:

- Short-circuit braking (dynamic braking);
- The text "Undervoltage" appears in the message window;
- System variable "\$STOPMESS" is set to 1 (True);
- System variable "\$POWER_FAIL" is set to 1 (True);
- Backup routine starts, all modified files saved;
- Machine switches off automatically.

The next time the system is booted, the initial state of the user interface is restored. If, for example, forms were open or a program was loaded into the editor before the power failure, they will not be displayed after the restart.

The state of the kernel system, including programs, block pointer, variable contents, outputs, status messages and acknowledgement messages, is completely restored.



In the case of a restart after software problems, program resumption is only possible in isolated cases.

All outstanding changes that have not yet been saved are lost after a shutdown.



If there was an error present in the kernel system at the time of the power failure, or if the system is shut down during a cold start, the system generates the file “vxworks.debug”. KUKA can use this file to analyze the error.
The system restart then occurs as a cold start.

If a cold start is actively desired the next time the system is booted, the option “Configure” -> “On/Off options” -> “Force cold Startup” is available for this purpose.

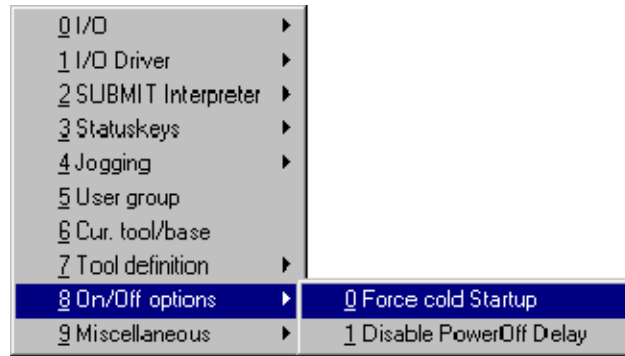

The menu command “Force cold startup” does not remain selected, i.e. it must be activated each time a cold start is required.

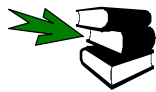

Further information on the setup and configuration of the warm restart can be found in the **Programming Handbook** in the documentation [Configuration], chapter [Configuring the system].

1.7.2.1 Hardware requirements

Only power modules from version “E” onwards support the backup routine. This can last up to 200 seconds, while older modules automatically switch off after 70 seconds.

In the event of a warm restart, the system configuration at the time of the power failure is restored. The interpreter is returned to the point at which the program was interrupted, for example, and the output image is restored. The restoration of the output image places particular requirements on the system design.

In manual mode, the output periphery is linked to the system outputs “\$PERI_RDY” and “\$STOPMESS”. In this way, changes to the status of the cell can only be made if the drives are switched (enabling switch pressed and Emergency Stop acknowledged).



All peripheral devices which can trigger potentially dangerous movements in the cell must be designed using pulse valve technology. This prevents unintentional movements from occurring when the power supply is switched off or back on.

1.7.2.2 Power failure with the system running

In the event of a power failure during normal operation, the robot is stopped by short-circuit braking (dynamic braking). A corresponding message is generated in the message window.

The system variables “\$STOPMESS” and “\$POWERFAIL” are then set to “TRUE”.



An active application should react to the power failure with the KRL command “SYNC()”. If this message does not appear, a corresponding error message is generated.

It makes no difference whether the power failure was caused by failure of the mains supply or by pressing the main switch during program execution.

All kernel system files with the archive bit are saved on the hard disk. Once the files are saved, the system waits until the PowerOff wait time has elapsed. This is then followed by one of two eventualities:

When the wait time elapses the power has returned

The robot system is not switched off and the system variable “\$POWER_FAIL” is set to “FALSE” again. The message in the message window must then be acknowledged before work can be resumed.

When the wait time elapses the power is still absent

The entire kernel system state is backed up on the hard disk in the file “vxworks.freeze” and the controller is shut down, in a controlled manner, by the battery back-up (see Section 1.8). All system files are saved in the usual way.

The control system is then switched off.



If the battery back-up is not sufficient, in exceptional circumstances files could be destroyed. In such cases the system attempts a cold start.

Loss of mastering may occur if the battery voltage fails before the mastering data are saved.

When power is restored the controller is automatically run up and selects the program that was previously running. Program execution can be resumed from the point at which the program was interrupted. There are two ways of doing this:

- If the robot is located on its programmed path (e.g. ramp-down braking), the program can be started using the “start continue” function.
- If the robot has left its programmed path (e.g. short-circuit braking), a BCO run may be necessary at the point where the path was left (RET position).

1.7.2.3 Power failure during a cold start

The variable “\$POWER_FAIL” is set to the value “TRUE” and the system booting procedure is aborted. In some cases a processor reset may be triggered and a cold start carried out once the power has returned.

1.7.2.4 Power failure during a restart

The control software is completely restarted. The subsequent sequence of events then corresponds to that described in Section 1.7.2.2.



1.7.3 Setting external power supply and user outputs

External power supply

The computer unit in the robot controller can be supplied separately by an external power supply (option). A 24-volt power source is required here, which works independently of the normal power supply. In the event of a mains power failure, the computer unit is not shut down.

Deactivating the user outputs

In the event of a power failure with a functioning external power supply, the user outputs are not normally deactivated. Should this be desired, however, the variable "IO_SYS_DOWN_ON_24V" must be set to "TRUE".





When power returns, the user outputs are restored.

1.8 Battery charge monitoring

Normally, when the system is shut down, or in the event of a power failure, the robot system data are automatically backed up. The batteries used for backing up the computer system are accommodated in the control cabinet.

1.8.1 KR C1 response

If the battery voltage drops too far during the backup procedure (below 22 V), an error message is generated in the message window.

	Time	no.	Source	Message
	10:45 0		TPUSER	Initialization in progress
	10:45 0		TPUSER	Initialization finished
	10:45 38		BOF	PowerOn finished.
	14:52 4			Buffer battery voltage low PM1



If this message is generated during normal operation, a short-circuit has occurred in the battery.



No error message is generated as a result of disconnecting the batteries during normal operation.

The error message can have the following causes:

- The batteries are not fully charged.
 - Cause: System switched on/off many times in quick succession.
 - Remedy: Leave the robot controller running for at least 10 hours, so that the batteries can be completely recharged. If this does not help, the battery is defective.
- One or both batteries are defective.
 - Remedy: Replace **both** batteries immediately, **WITHOUT** switching off the robot controller (could result in faulty files or damage to the operating system).



Use only batteries that have been specially released by KUKA. No guarantee can otherwise be provided for the correct functioning of the system.

1.8.2 KR C2 response

If the battery voltage drops too far during the backup procedure (below 22 V), an error message is generated in the message window.

	Time	no.	Source	Message
!	10:45 0		TPUSER	Initialization in progress
!	10:45 0		TPUSER	Initialization finished
!	10:45 38		BOF	PowerOn finished.
!	14:52 4			Buffer battery voltage low PM1



If this message is generated during normal operation, a short-circuit has occurred in the battery.



No error message is generated as a result of disconnecting the batteries during normal operation.

The current state of the batteries is saved at the end of the backup procedure. Next time the system is booted, a corresponding message is generated:

Voltage below 22 volts

	Time	no.	Source	Message
!	10:45 0		TPUSER	Initialization in progress
!	10:45 0		TPUSER	Initialization finished
!	10:45 38		BOF	PowerOn finished.
!	14:57 284			Accu-voltage at PM1 below 22 during last buffering.

This message indicates that enough voltage remains to back up the system data.

Voltage below 19 volts

	Time	no.	Source	Message
!	10:45 0		TPUSER	Initialization in progress
!	10:45 0		TPUSER	Initialization finished
!	10:45 38		BOF	PowerOn finished.
!	15:00 284			Accu-voltage at PM1 below 19 during last buffering.

If this message appears, operating system or robot system data may be damaged as the computer was switched off before completion of the backup procedure. The system is switched off in order to protect against an exhaustive discharge (and thus destruction) of the batteries.

These messages can have two causes:

- The batteries are not fully charged.
 - Cause: System switched on/off many times in quick succession.
 - Remedy: Leave the robot controller running for at least 10 hours, so that the batteries can be completely recharged. If this does not help, the battery is presumably defective.
- One or both batteries are defective.
 - Remedy: Replace **both** batteries immediately, **WITHOUT** switching off the robot controller (could result in faulty files or damage to the operating system).



Use only batteries that have been specially released by KUKA. No guarantee can otherwise be provided for the correct functioning of the system.

The message in the message window can be neither deleted nor acknowledged. This message is deleted automatically, but not until the next battery backup procedure has been successfully completed without the battery voltage falling too far.

Signal output “\$LAST_BUFFERING_NOTOK”

If the battery voltage falls below 22 or 19 volts during the backup procedure, in addition to the generation of error messages, the output “\$LAST_BUFFERING_NOTOK” is set to “TRUE”. This makes it possible to react to the situation accordingly with the peripheral equipment connected.

1.9 Virus protection

The control software package delivered with the controller includes a virus protection program to protect it from computer viruses.

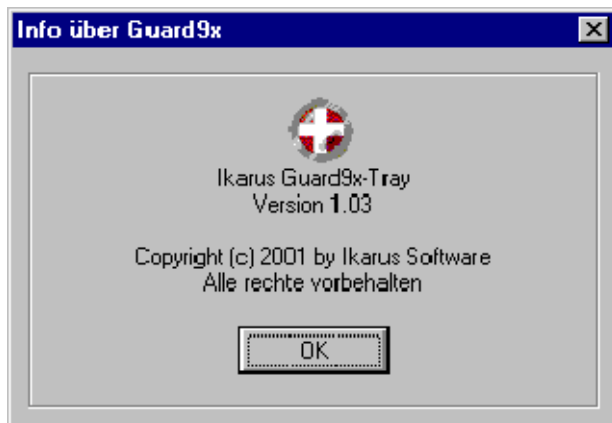

When the robot system is switched on, the Ikarus Software “Virus Utilities” program is started. At the start of the program, an information window is briefly activated and the main memory is searched.

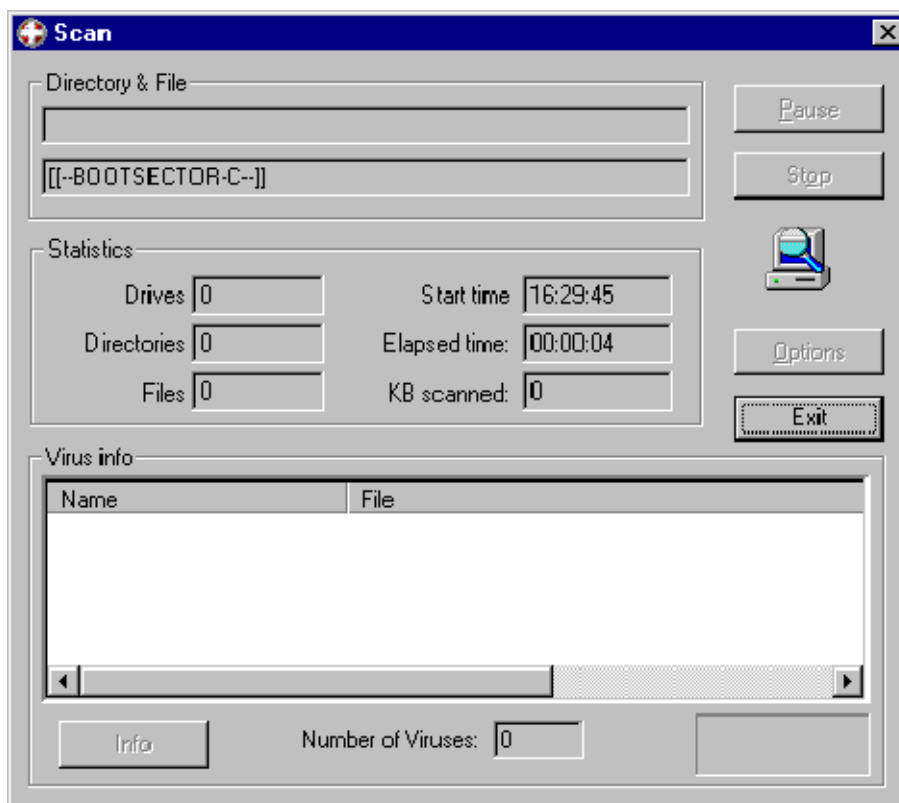

It is not possible to remove a virus until the controller has booted completely.

The program “Ikarus-Guard”, which runs in the background, is then started; this is indicated by an icon in the Windows taskbar.



1 Running up / shutting down the controller (continued)

This program continually monitors the system's main memory and drives.



In order to search for or remove viruses manually, it is necessary first to switch to the Windows interface. Depending on the configuration, the user group "Expert" must be accessed.

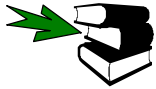

Further information about switching to the Windows interface can be found in the chapter [The KUKA Control Panel KCP].

If a virus is discovered during operation, e.g. while accessing a floppy disk or network drive, a corresponding virus warning is generated.

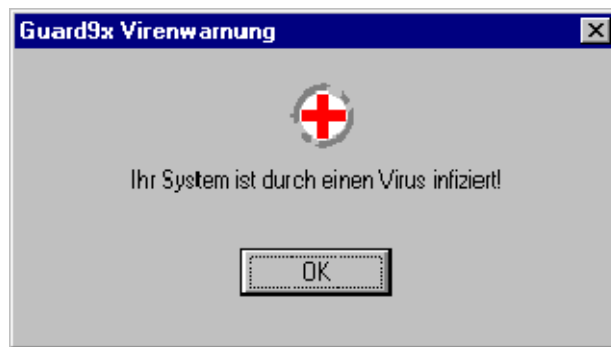

If this happens, please start the Virus-Utilities program via the Windows Start menu. Open the Start menu using the keyboard shortcut "CTRL" + "ESC" and select the relevant program using the arrow keys. Then press the Enter key.

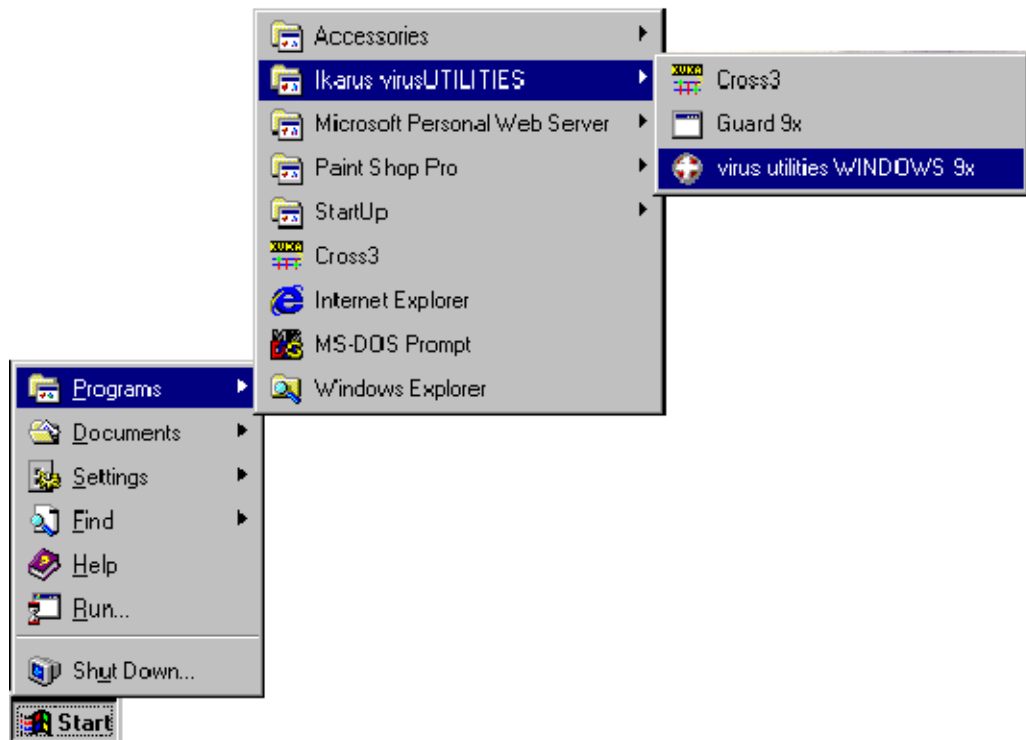

The following window is then opened:

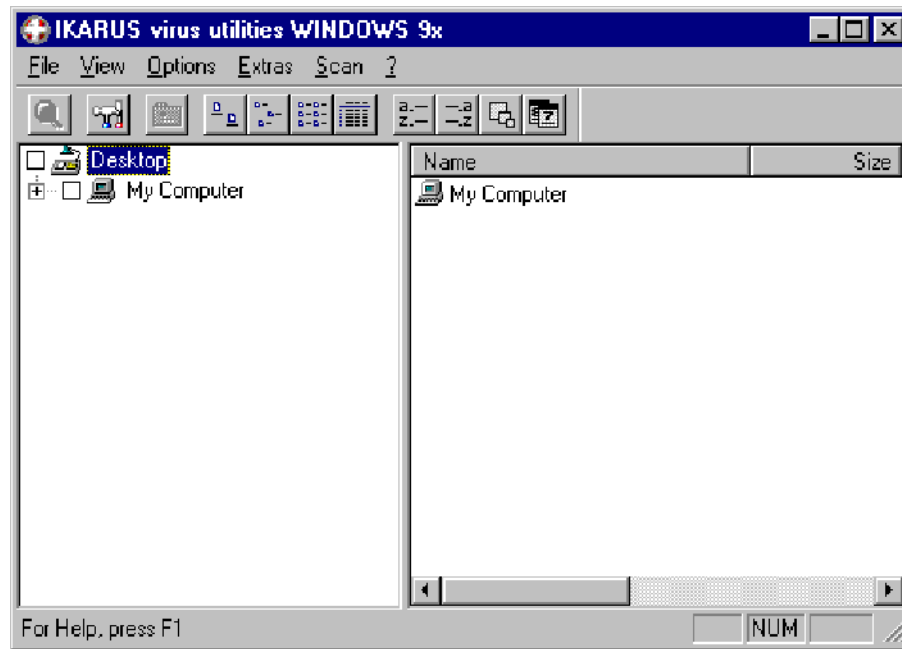

The virus scanner does not, by default, intervene in the execution of the KRC software. This default setting must be changed in order to be able to search for or delete a virus. To do this, open the “Options” menu and select the entry “Settings”.

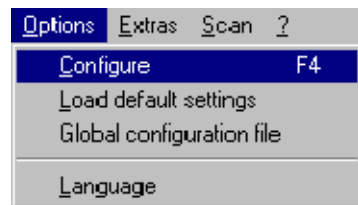

Activate the following option in the window which now opens and accept the settings by pressing “OK”:

1 Running up / shutting down the controller (continued)

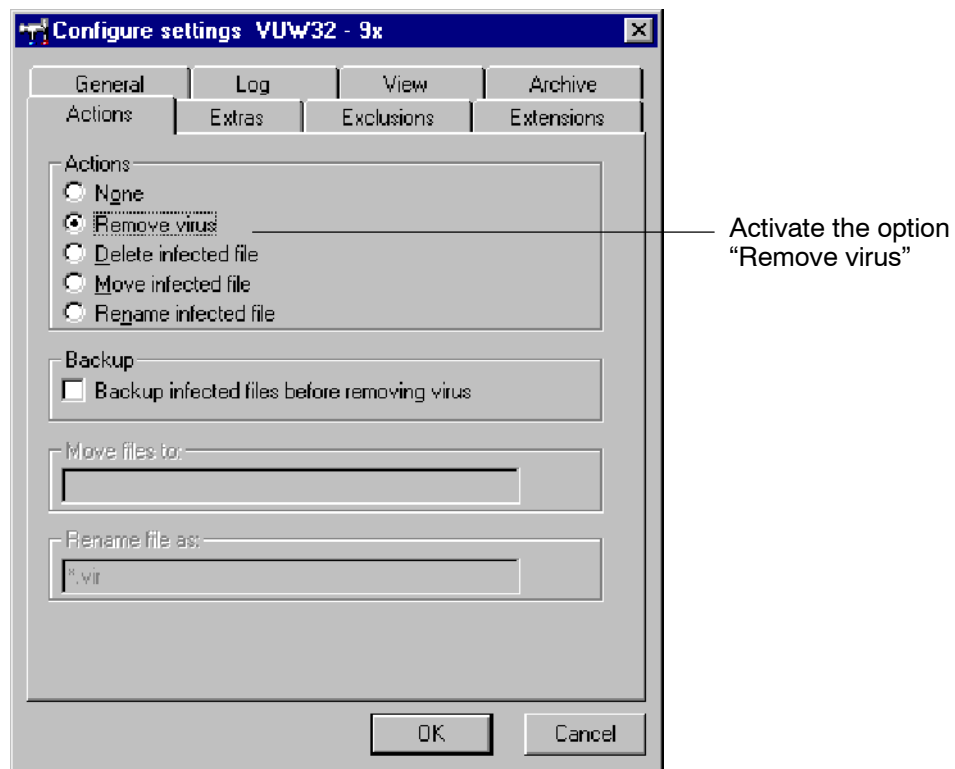

Now select the directories which are to be searched.

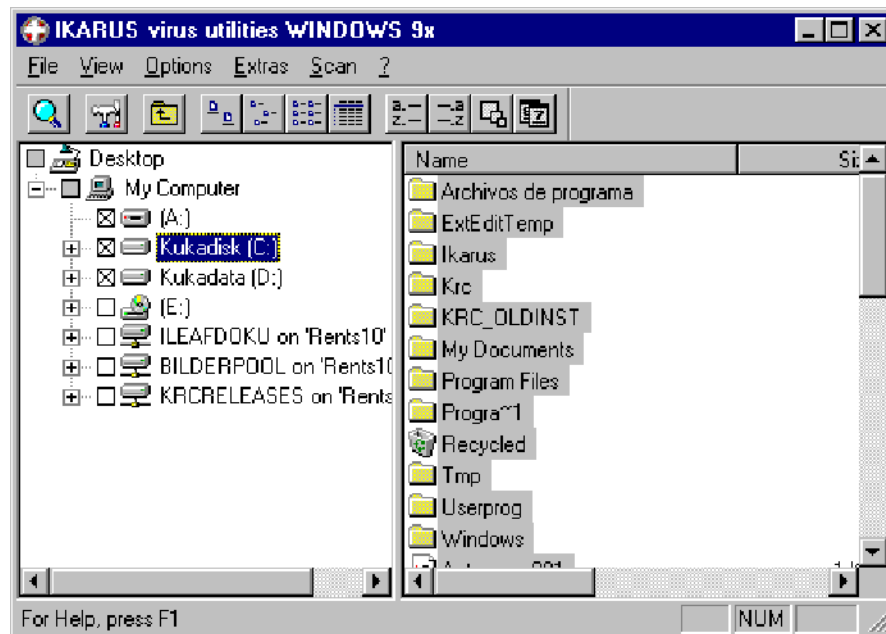

Start the virus scanner by selecting the "Scan" function in the menu of the same name and pressing the Enter key.

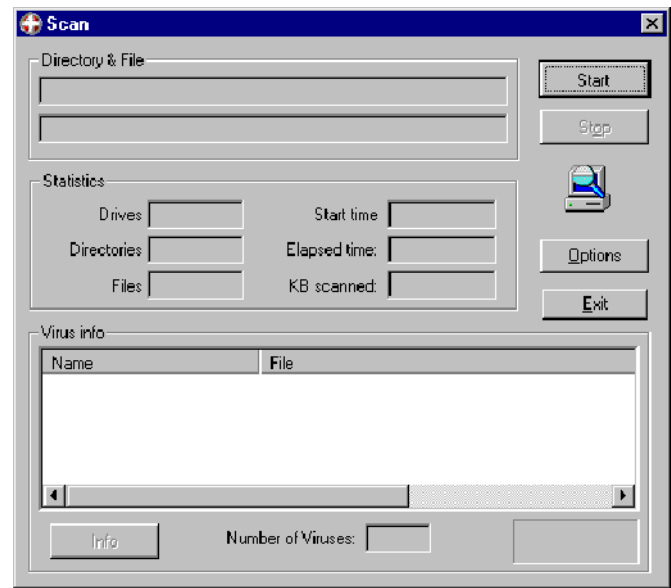
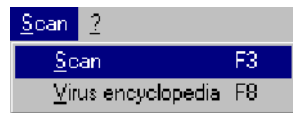

The virus scanner then searches the specified drives and directories. Every virus detected by the scanner is indicated in a dialog window and can be deleted by confirming the message.

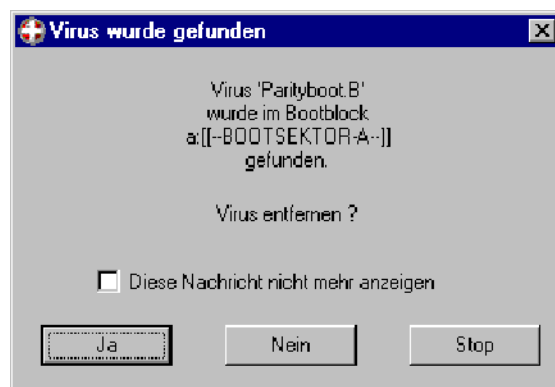

If files in the operating system or robot control software are infected by viruses, the software in question should be reinstalled as a precautionary measure once the viruses have been deleted.

Finally, a summary is displayed of the drives searched and the viruses found.

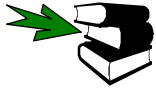
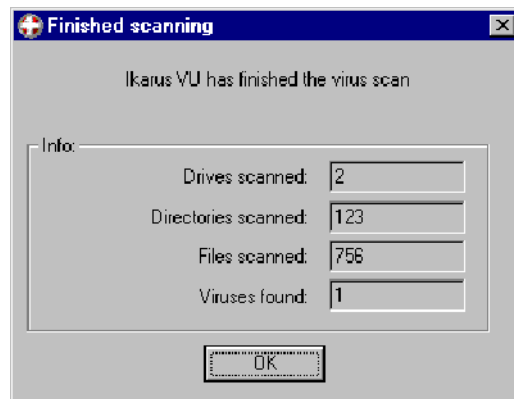

Further information about the virus scanner can be found in the instructions delivered with the scanner.



It is in your own interest to make sure that you always use the latest version of the virus scanner.



2 The KUKA Control Panel KCP

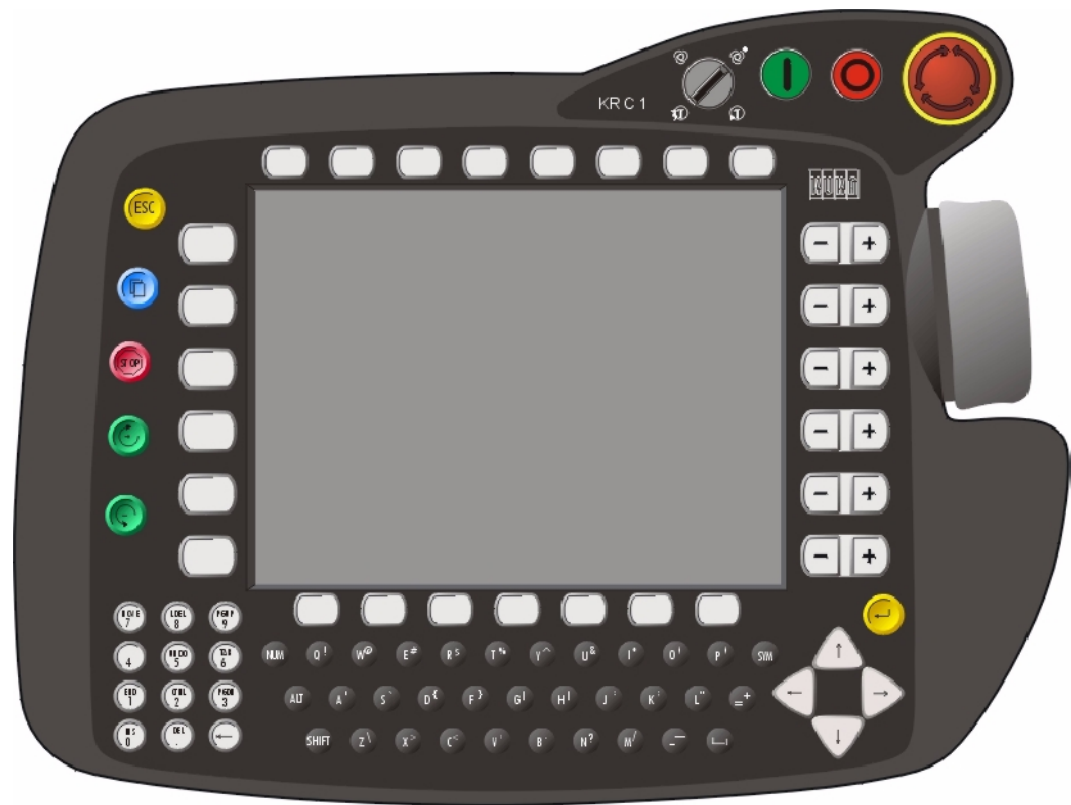

2.1 General

The KUKA Control Panel, referred to hereafter as “KCP”, forms the interface between man and machine and is used for easy operation of the “KR C...” robot controllers. All elements required for programming and operator control of the robot system, with the exception of the main switch, are located directly on the KCP. Due to its ergonomic design and its lightness, the KCP can be used not only as a console unit but also as a handheld unit. The holding domes and enabling switches on the back of the KCP are arranged in such a way that the KCP can be easily used by both left-handed and right-handed people.

The VGA color-graphic LCD display helps to visualize operator and programming actions. If you have already worked with the operating system “Windows”, you will find many familiar features and elements on the user interface.

The following description gives you an overview of the KCP’s operator control elements and graphical user interface.

2.2 Operator control elements of the KCP

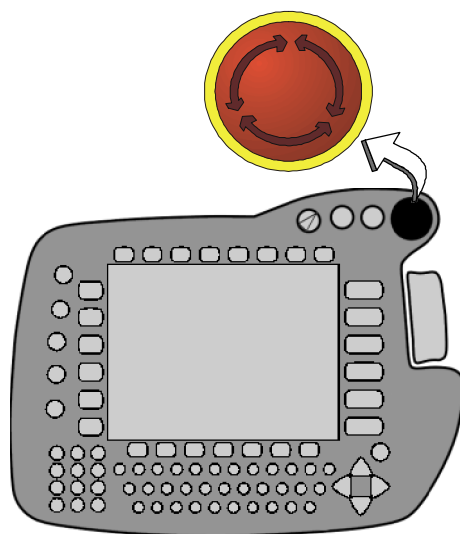

EMERGENCY STOP button

The EMERGENCY STOP button is the most important safety element. This red slam pushbutton is pressed in dangerous situations and causes the drives of the robot to be switched off immediately.

Before the drives can be switched on again, the EMERGENCY STOP button must be released. To do so, turn the top of the button clockwise until it audibly disengages. The associated EMERGENCY STOP message in the message window must then be acknowledged by pressing the softkey “Ack”.

Pressing the EMERGENCY STOP button activates path-oriented braking.



Before the EMERGENCY STOP button is released, the situation that caused the stop to be triggered, and if necessary its consequences, must first be rectified.

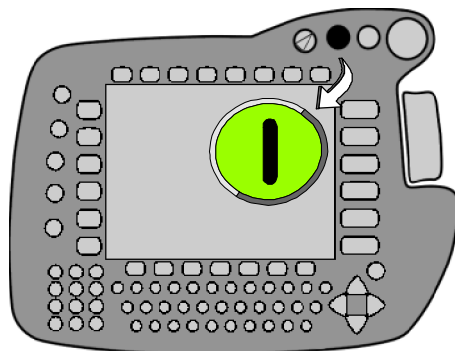

Drives ON

Pressing this pushbutton switches the drives of the robot on.

These can only be switched on under normal operating conditions (e.g. no EMERGENCY STOP button pressed, safety gate closed, etc.).

If the “Manual” mode is set, this pushbutton has no function (see also “Mode selection”).

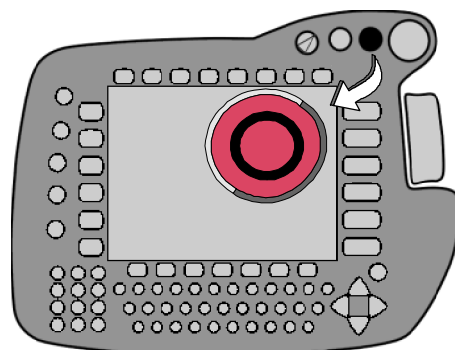

Drives OFF

Pressing this pushbutton switches the drives of the robot off. The brakes of the motors are also engaged after a slight delay and keep the axes in their positions.



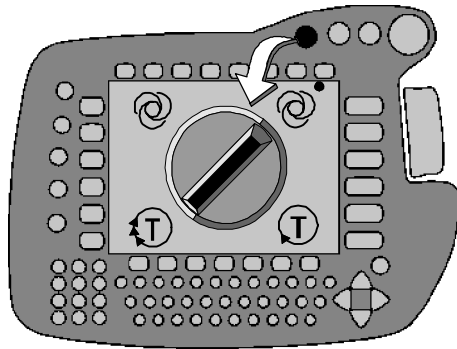

If the “Manual” mode is set, this pushbutton has no function (see also “Mode selection”).

Drives OFF activates dynamic braking.



Mode selection

Using this keyswitch you can switch between the following operating modes:

-  **Test 1**
The robot moves only as long as one of the enabling switches (on the rear of the KCP) is held down.
Movements are executed at a reduced velocity.
-  **Test 2**
The robot moves only as long as one of the enabling switches (on the rear of the KCP) is held down.
Movements are executed at the programmed velocity.
-  **Automatic**
The robot executes the selected program automatically and is monitored using the KCP.
Movements are executed at the programmed velocity.
-  **External**
The robot executes the selected program automatically and is controlled using a host computer or a PLC.
Movements are executed at the programmed velocity.

If the operating mode changes while the program is running, dynamic braking is activated.



Automatic operation is only possible with the safety circuit closed.

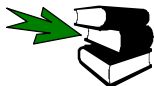

Further information can be found in the chapter **[Executing, stopping and resetting programs]**.

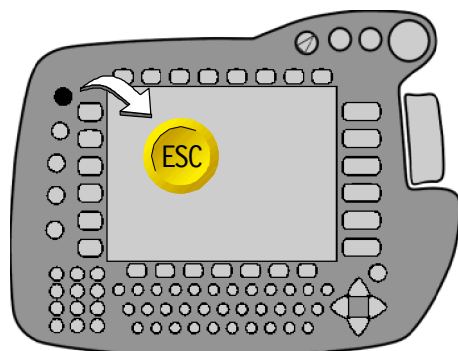

Escape key (ESC)

An action that has been started can be aborted at any time using the Escape key. This includes, for example, open inline forms and status windows.

Menus opened by mistake can also be closed again, one by one, by pressing this key.

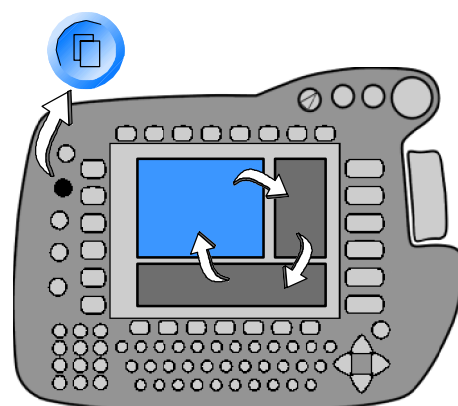

Window selection key

With this key, you can switch between the program, status and message windows if they are available.

The background of the selected (activated) window is highlighted in color.

This activation is also called the “focus” in this handbook.

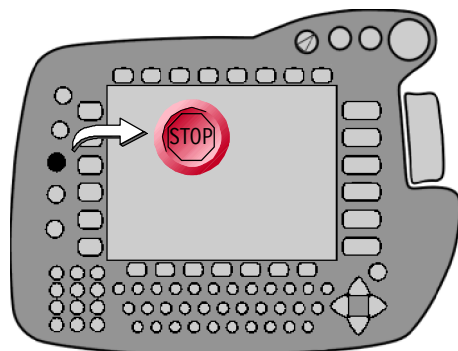

Program STOP

Pressing this key stops a program that is running.

Path-maintaining braking is carried out and this can be acknowledged in automatic mode.

To resume a program that has been stopped, press the “Program start forwards” key.

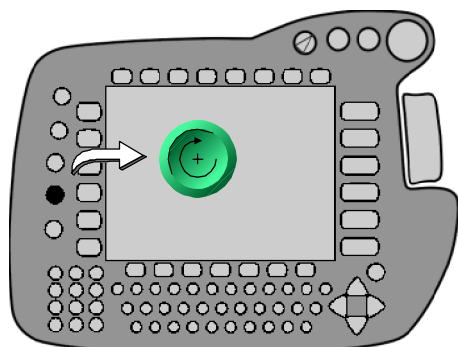

Program start forwards

This key is used to start a selected program.

A program is only be started if the drives are switched on and there is no EMERGENCY STOP situation.

Releasing the “Program start forwards” key in jog mode (T1 or T2) triggers path-maintaining braking.



To start the robot in the jog mode – T1 and T2 – one of the enabling switches must be held down and then the “Program start forwards” key must be pressed. This start key must be held down during program execution.

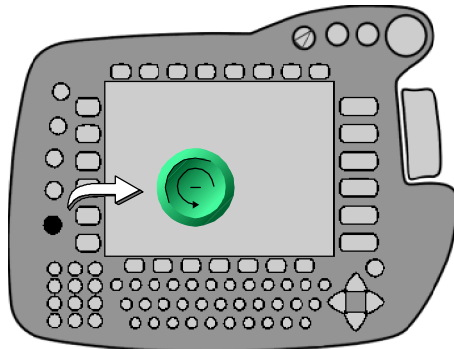

Program start backwards

By pressing this key, the motion blocks of the selected program are executed step by step towards the **beginning** of the program.

The robot is thus moved in reverse direction along the path originally programmed.

This movement is used, for example, for subsequently teaching intermediate points in circular motions.

Releasing the “Program start backwards” key triggers path-maintaining braking.

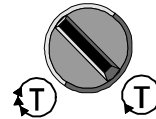

This function is only available in the operating modes T1 (Test1) and T2 (Test2).

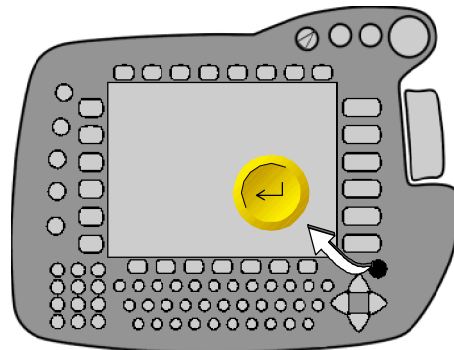

Enter key

This operator control element corresponds to the “Enter” or “Return” key that you know from a PC keyboard.

It is used to conclude commands, confirm entries in forms, etc.

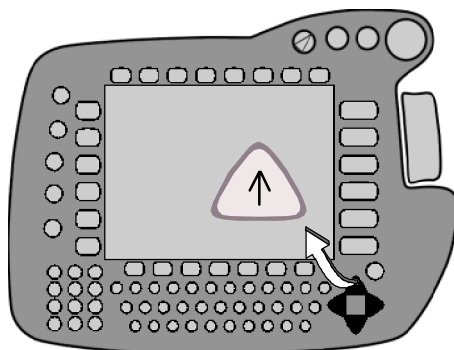

Arrow keys ← ↑ ↓ →

The arrow keys are used to

- change the position of the edit cursor, and
- move between boxes in inline forms and parameter lists.

To do so, press the corresponding arrow key. The functions, including the repetition function and the repetition rate, are similar to those of a PC keyboard.

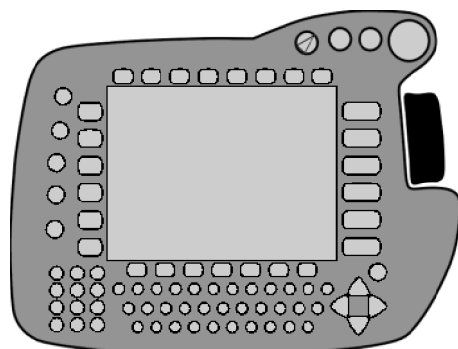

Space Mouse

This operator control element is used for the manually controlled motion of all 6 axes (degrees of freedom) of the robot. The magnitude of the deflection affects the velocity of the robot.

Alternatively, the -/+ status keys on the right-hand side of the display can also be used.

See also chapter [Manual traversing of the robot].

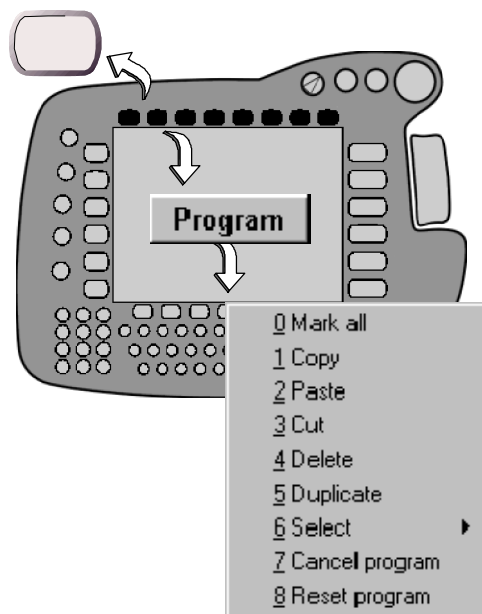

Menu keys

These keys are used to open a menu in the menu bar (at the top of the display).

You can select from the menu that is opened as follows:

- by using the (↓ ↑) arrow keys, which highlights the selected menu item in color, and then pressing the Enter key

or

- by using the numeric keypad to enter the numbers preceding the desired menu item.

A menu can be closed one step at a time by pressing the Escape key as often as required.

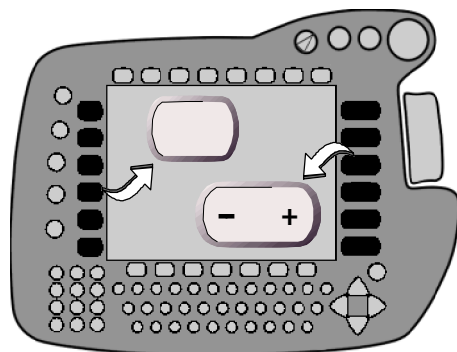

Status keys

The status keys (on the left and right of the display) are used for selecting operating options, switching individual functions and setting values.

The respective functions are graphically indicated by icons in the status key bar. See also Section 2.4 (Status key bar).

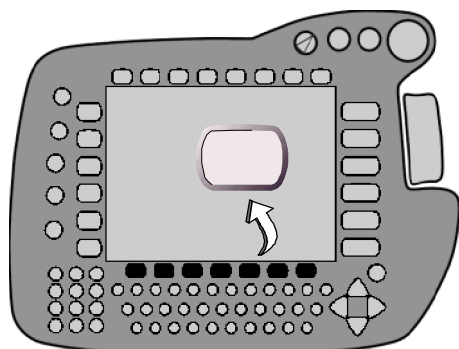

Softkeys

These operator control elements are used to select the functions indicated in the softkey bar (at the bottom of the display).

The functions available are dynamically adapted, i.e. the assignment of the softkey bar is altered.

Further information can be found in Section 2.4 (Softkey bar).

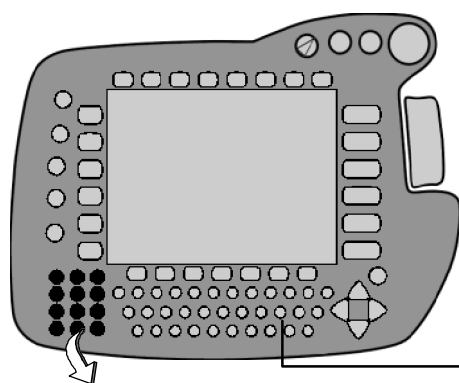

Numeric keypad

The numeric keypad is used for entering numbers. On a second level, the numeric keypad is assigned cursor control functions.

The "NUM" key on the keyboard is pressed briefly to switch between these levels.

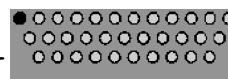

The "NUM" box in the status line of the display indicates the currently active function of the numeric keypad:

Numeric input activated



Cursor control functions activated



HOME
Jumps to the beginning of the line in which the edit cursor is positioned.

LDEL
Deletes the line in which the edit cursor is positioned.

PGUP
Moves one screen towards the beginning of the file.

UNDO
Cancels the last entry (not yet implemented).



TAB
Tab jump

END
Jumps to the end of the line in which the edit cursor is positioned.



PGDN
Moves one screen towards the end of the file.

INS
Switches between insert and overwrite modes.
The set mode is indicated in the status line as follows:



CTRL
Control key; e.g. for program-specific commands.

DEL
Deletes the character to the right of the edit cursor.



Arrow ←
Backspace key; deletes the character to the left of the edit cursor.

Keyboard

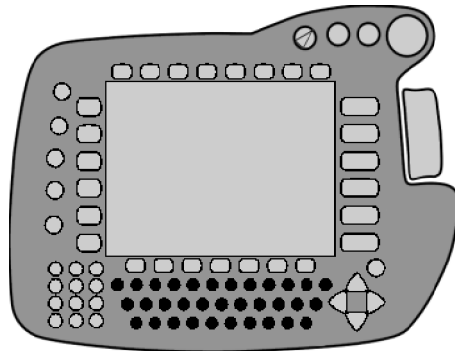

You can switch between lower-case and upper-case letters by means of the “SHIFT” key.

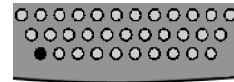

If the shift key is pressed once, the next character will be typed in upper case. To type upper-case characters, the shift key must be held down while the characters are entered. It is also possible to switch to continuous upper-case characters (**Caps Lock**) using the keyboard shortcut “SYM”+“SHIFT”. For control purposes, “Caps” in the status line will be changed from gray to highlighted.

Caps Lock inactive



Caps Lock active



Punctuation marks and special characters are available on a second keyboard level. You can switch to this level by pressing the “SYM” key.

If the “SYM” key is pressed once, the corresponding punctuation mark or special character will be typed next. To obtain a locking function, this key must be held down while characters are entered.

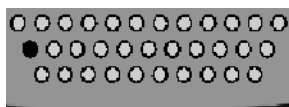

In certain applications, e.g. auxiliary programs, it is possible to control functions by means of key combinations (e.g. “ALT”+“TAB”). On the KCP, the “ALT” key is located in the position shown on the left.

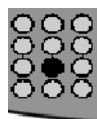

The “CTRL” key is located on the numeric keypad. Before the “CTRL” key can be used, the numeric keypad must be switched to the cursor control functions (see the description “Numeric keypad”).



The “SHIFT”, “ALT”, “CTRL” and “SYM” keys remain activated for one keystroke, i.e. if the “SHIFT” key is pressed, for example, and then released, it is active for the next keystroke.

2.3 The rear of the KCP

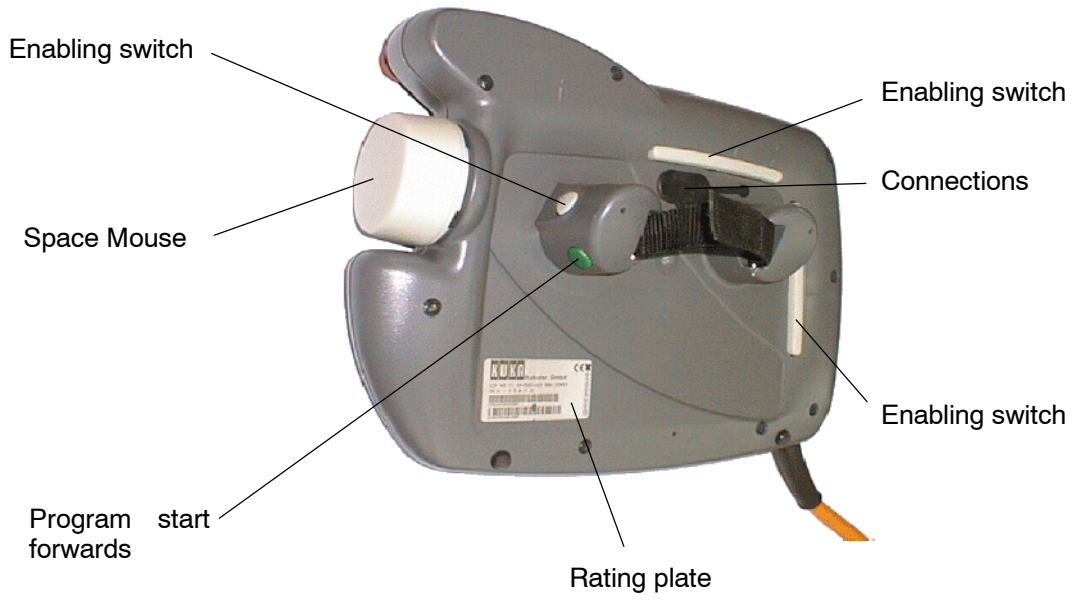

2.4 Graphical user interface (GUI)

The display of the KUKA Control Panel is subdivided into several areas with various functions. These are dynamically adapted to the different requirements during operation.

The elements of the graphical user interface include the menu bar, the status key bars and the softkey bar, the program window, the inline forms, the status and message windows and a status line.



These are illustrated below on the basis of examples. The assignment of the menu, status and softkey bars depends on the applications installed.

2.4.1 Settings for brightness and contrast

For the sake of greater clarity of the graphical user interface, both the brightness and contrast of the LCD display can be adjusted.



The manual traversing function must be switched off first before the brightness and contrast can be changed. The status key “Traversing mode” is located at the top left of the display.



The two status keys on the righthand side of the display are used for setting the brightness and contrast. The respective values can be changed from 0...15 by pressing the corresponding +/- status key.

2.4.2 Function keys

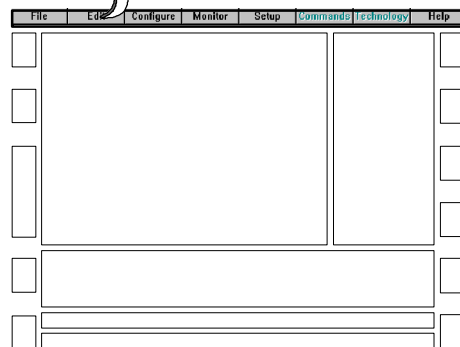

Menu bar

Robot controller functions are grouped together in the menu bar.

These groups (menu items) must be opened using the menu keys (above the display) to access the next function level.

Further information on the **menu keys** can be found in Section 2.2.



Status key bars

The status key bars show the changeable functions of the status keys to the left and right of the display.

The appearance of, or the functions assigned to, the status keys change during execution of the program.

Further information on the **status keys** can be found in Section 2.2.

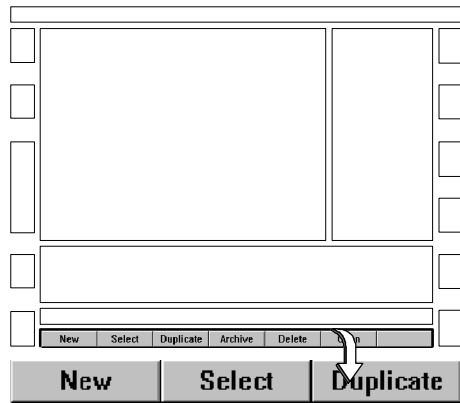

Softkey bar

The softkey bar, which adapts itself dynamically, offers functions that can be selected using the softkeys (at the bottom of the display).

Further information on the **softkey bar** can be found in Section 2.4.6.

2.4.3 Input/output windows

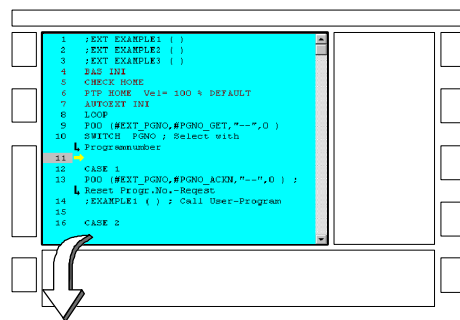

Program window

The program window shows the contents of the selected program. If there is no program selected, a list of the available programs is displayed in the program window.

Located between the line number and the text of the instruction, or statement, is a yellow arrow pointing right, the “block pointer”. This indicates the program line that is currently being executed.

Block pointer (program pointer)

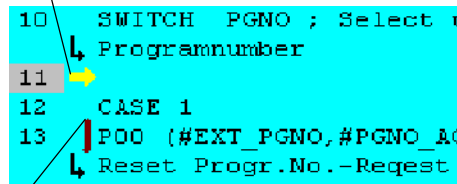

Another marker is the “edit cursor”, a vertical red line. The edit cursor is located at the beginning of the line that is currently being edited.

Further information on the use of the block pointer is provided in Section 6.4.3.

Edit cursor

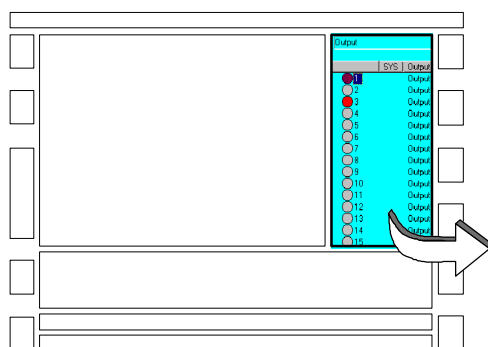

Status window

The status window is opened as required for display purposes (e.g. assignment of outputs) or for entry of data (e.g. during tool calibration).

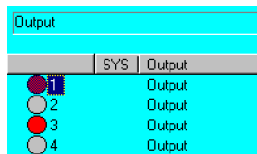

You can move between the input boxes using the “↓” and “↑” arrow keys.

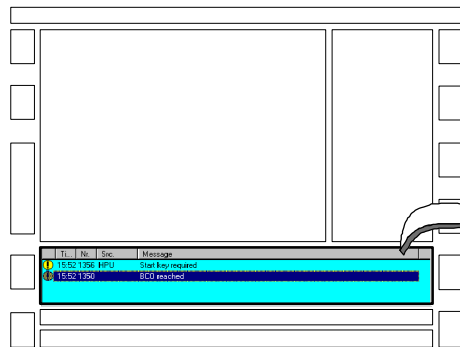

Message window

The controller communicates with the operator via the message window. Notification, status, acknowledgement, wait and dialog messages are displayed here.

Ti...	Nr.	Src.	Message
15:52	1356	HPU	Start key required
15:52	1350		BCD reached

Each type of message has a specific symbol assigned to it. Further information can be found in Section 2.4.5.

If the message text does not fit in one line, the remainder of the text is automatically cut.

Ti...	no.	Source	Message
13:40	1356	HPU	Start key required
13:41	2	TPBASIS	Do you want to teach point "PointOfNoReturn" (TOOL_DATA[1], \$WO



In order to view the entire message text, select the relevant line using the arrow keys. Then press the Enter key. The complete message text is then displayed.

Ti...	no.	Source	Message
13:45	2	TPBASIS	Do you want to teach point "PointOfNoReturn" (TOOL_DATA[1], \$WORLD, #BASE)

The "ESC" key takes you back to the normal display.

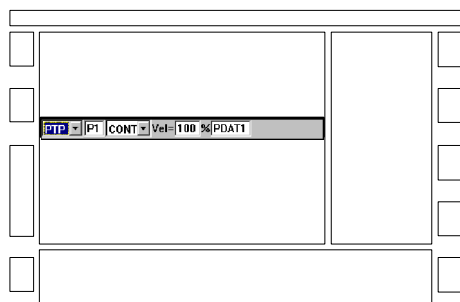

Inline form

Some of the program functions require values to be entered.

These values are entered in an input mask (inline form) or selected from inline sub-menus.

In this way, you ensure that the programmed instructions always have the correct format.

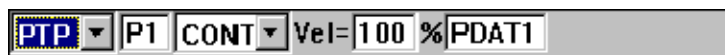

You can move between the input boxes using the "↓" and "↑" arrow keys.

2.4.4 System status

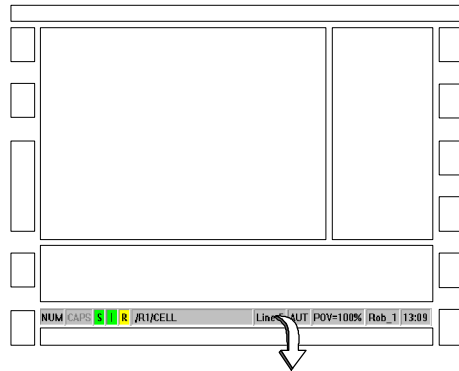

Status line (status bar)

The status line provides a collection of information on important operating statuses.

This includes information on the status of the PLC or a program.

More detailed information on the indications of the **status line** can be found in Section 2.4.6.



2.4.5 Messages

The symbols displayed in the message window have the following meaning.

Notification messages contain information or indicate operator actions, programming errors and operator errors. They are purely for information purposes and do not interrupt program execution.



Start key required

This message appears after a program has been selected.

Status messages indicate the status of the system. They are also informational in character and can interrupt the application program to a certain extent. Status messages are automatically deleted when the status that triggered them is no longer applicable.



EMERGENCY STOP

This message is generated if, for example, the EMERGENCY STOP button has been pressed or a safety gate opened.

Acknowledgement messages frequently appear following a status message (e.g. EMERGENCY STOP) and must be explicitly confirmed. They indicate disruption to program execution.



Confirm EMERGENCY STOP

Acknowledgement messages stop robot operation until the cause of the error has been eliminated and the message confirmed.

Wait messages are generated if a program is running and a wait condition is being executed.



WAIT FOR \$IN[1]==TRUE

The robot controller is stopped until the condition is fulfilled or the program reset. In this example the system is waiting for a signal at input 1.

The operator must respond to **dialog messages**. The result is stored in the relevant variable. The program is stopped until the message is acknowledged, and subsequently resumed.



Do you want to touch point "P1"?

The "yes" and "no" softkeys are now offered in the softkey bar. When one of the two softkeys is pressed, the message is deleted from the message window.

2.4.6 Status bar

The status bar gives you information about important operating states.



- NUM** → Numbers are entered using the numeric keypad.
- NUM** → The numeric keypad's cursor control functions are activated.



- CAPS** → Upper-case characters are switched on (all characters will be written in upper case)
- CAPS** → Upper case characters are deactivated (both lower and upper-case characters can be entered)



- S** → Gray: The "Submit" interpreter has been deselected.
- S** → Green: The "Submit" interpreter is running.
- S** → Red: The "Submit" interpreter has been stopped.



- I** → Green: The drives are ready.
- I** → Red: The drives are not ready.



- R** → Gray: No program has been selected.
- R** → Yellow: The block pointer is located in the first line of the selected program.
- R** → Green: A program has been selected and is currently being executed.
- R** → Red: The selected and started program has been stopped.
- R** → Black: The block pointer is located in the last line of the selected program.

NUM	CAPS	S	I	R	/R1/CELL	Line 5	AUT	POV=100%	Rob_1	13:09
-----	------	---	---	---	----------	--------	-----	----------	-------	-------

/R1/CELL → This box indicates the name of the selected program.

NUM	CAPS	S	I	R	/R1/CELL	Line 5	AUT	POV=100%	Rob_1	13:09
-----	------	---	---	---	----------	--------	-----	----------	-------	-------

Line 5 → This box indicates the block number of the program line currently being executed.

NUM	CAPS	S	I	R	/R1/CELL	Line 5	AUT	POV=100%	Rob_1	13:09
-----	------	---	---	---	----------	--------	-----	----------	-------	-------

T1 → Operating mode T1 (manual mode/jog mode).

T2 → Operating mode T2 (manual mode/jog mode).

EXT → Operating mode in which a host computer or PLC assumes control of the robot system (Automatic External).

AUT → Operating mode (Automatic).

NUM	CAPS	S	I	R	/R1/CELL	Line 5	AUT	POV=100%	Rob_1	13:09
-----	------	---	---	---	----------	--------	-----	----------	-------	-------

POV=100% → The Program override (the traversing velocity) in this example is set at 100% of the process velocity.

HOV=50% → The Jog override (for manual traversing); in this example the set traversing velocity is 50%.

NUM	CAPS	S	I	R	/R1/CELL	Line 5	AUT	POV=100%	Rob_1	13:09
-----	------	---	---	---	----------	--------	-----	----------	-------	-------

Rob_1 → The name of the robot is shown here.

NUM	CAPS	S	I	R	/R1/CELL	Line 5	AUT	POV=100%	Rob_1	13:09
-----	------	---	---	---	----------	--------	-----	----------	-------	-------

13:26 → The current system time.

2.4.7 Toggling to the Windows interface

It is possible to toggle to the Windows interface (only at Expert level) using various keyboard shortcuts. To do this, make sure that the “NUM” display in the status line is deactivated, so that you can use the numeric keypad’s control functions.

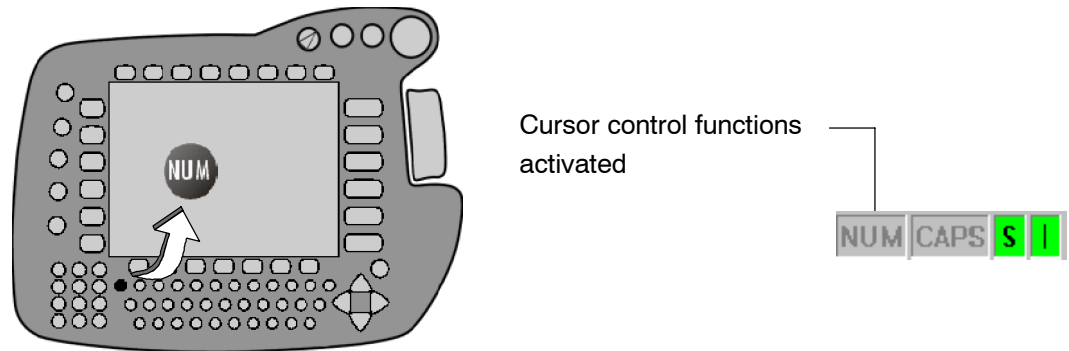

2.4.7.1 Alt-Tab

This combination makes it possible to toggle to another active program. These could include, for example, the programs “KR C...” and “Kuka-Cross 3”. Hold the “ALT” key down and repeatedly press the “TAB” key in the numeric keypad until the desired program is indicated. Then release both keys.

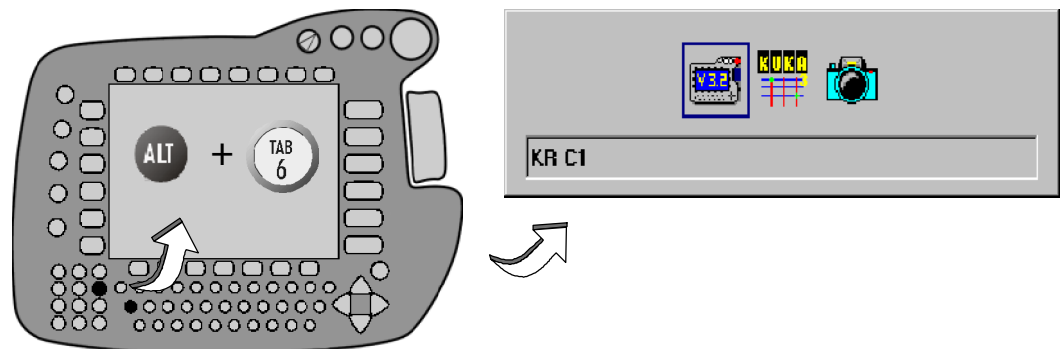

2.4.7.2 Alt-Escape

This returns you to the previous active application. Hold the “**ALT**” key down and repeatedly press the “**ESC**” key. Then release both keys.

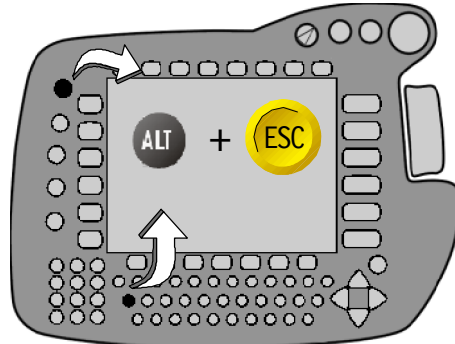

2.4.7.3 CTRL-Escape

The key combination “**CTRL**”+“**ESC**” allows you to open the Windows Start menu in order to call a different application using the arrow keys.

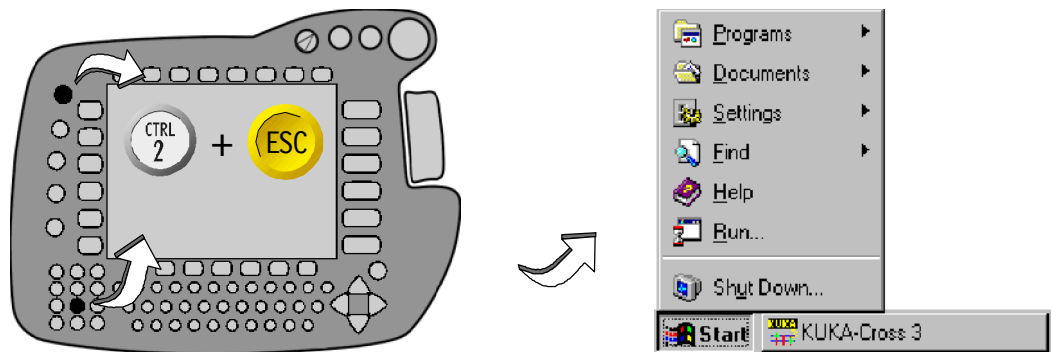

2.4.8 Windows mouse emulation using keys

This function enables you to move the mouse cursor using keyboard shortcuts and emulate the left and right mouse buttons. This option is deactivated by default.

Activate mouse operation by pressing the **“SYM”** key and then the **“Enter”** key. The function can be disabled again in the same way.

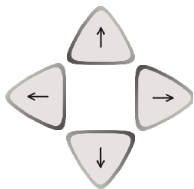
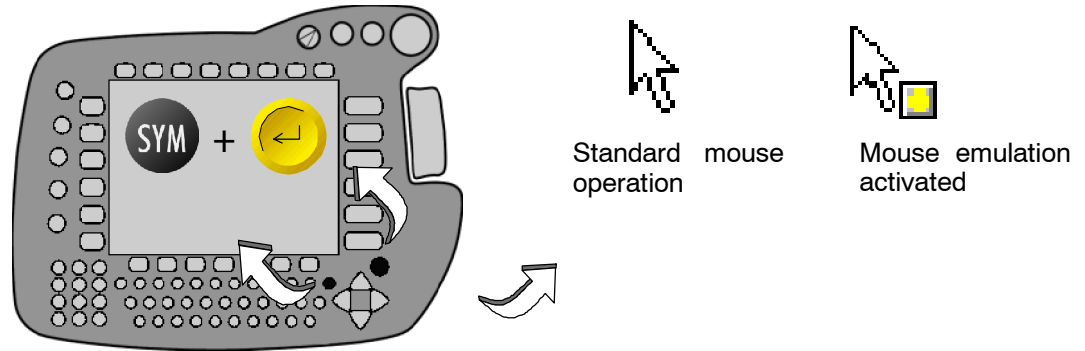

The mouse cursor can be moved in the desired direction using the arrow keys. If a key is held down, the mouse cursor moves with increasing speed in the desired direction.



The Enter key replaces the left mouse button.



The space-bar functions as the right mouse button.



The middle mouse button and “Drag and Drop” functions cannot be emulated.



3 Coordinate systems

3.1 General

To move the robot manually, using the Space Mouse or the traversing keys, you must select a coordinate system on which the robot movements are to be based.

For this purpose, you can choose from the following four systems, the use of which is explained in greater detail further on in this chapter.



Joint coordinate system

Each robot axis can be individually moved in positive or negative direction;



WORLD coordinate system

Fixed, rectangular coordinate system whose origin is located at the base of the robot;



BASE coordinate system

Rectangular coordinate system which has its origin on the workpiece that is to be processed;



TOOL coordinate system

Rectangular coordinate system, whose origin is located in the tool.



The robot moves in accordance with the reference coordinate system selected. This has the effect that the robot movements are different in, say, the TOOL coordinate system from those in the BASE coordinate system. More detailed information on this can be found in the following descriptions of the individual coordinate systems.



The reference coordinate system can only be changed in the “Manual traversing” mode. The status key “Traversing mode” at the top left of the display must show either the “Space Mouse” or “Traversing keys” symbol.

To select the desired coordinate system, repeatedly press the status key on the KCP illustrated below until the symbol for the desired coordinate system appears in the status key bar.

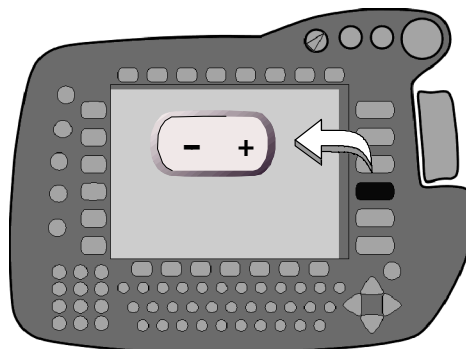

Further information can be found...

- ...in the chapter **[Manual traversing of the robot]** for information on moving the robot with the Space Mouse or the traversing keys.
- ...in the documentation **[Start-up]**, chapter **[Calibration – Tools and workpieces]** for information on calibrating tools and workpieces.

3.2 Joint coordinate system



In the joint coordinate system, each robot axis can be individually moved in positive or negative axis direction. This can be done using the traversing keys or the Space Mouse, the Space Mouse allowing 3 or 6 axes to be moved simultaneously.

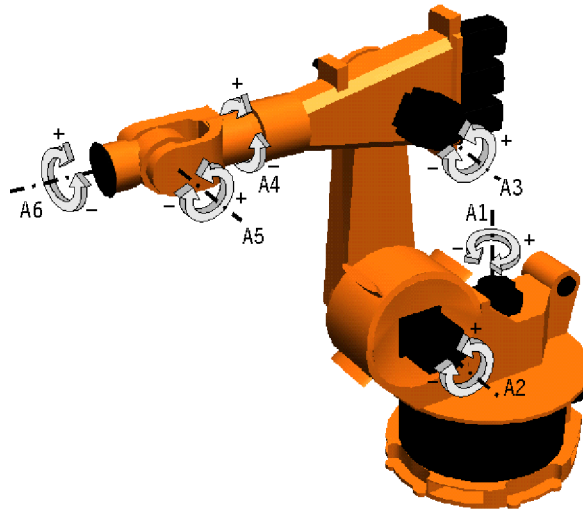

The following traversing keys/movements of the Space Mouse enable each axis to be moved individually:

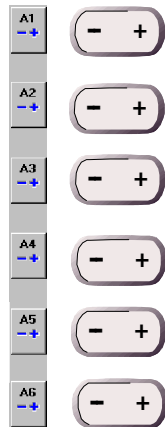

Traversing keys

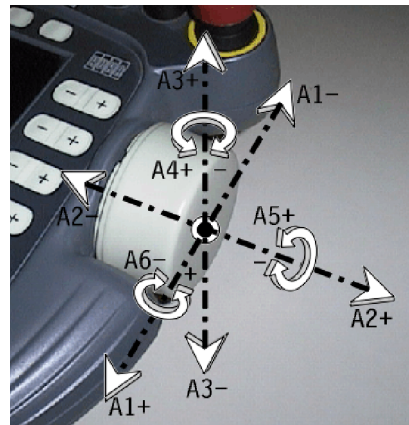

Space Mouse

3.3 WORLD coordinate system

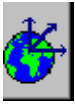

The WORLD reference coordinate system is an absolute (fixed), rectangular, cartesian coordinate system, the origin of which is generally located inside the work cell. The origin of the reference system remains in the same position when the robot moves, i.e. it does not move with it.
On delivery, the origin of the WORLD coordinate system is located in the base of the robot.

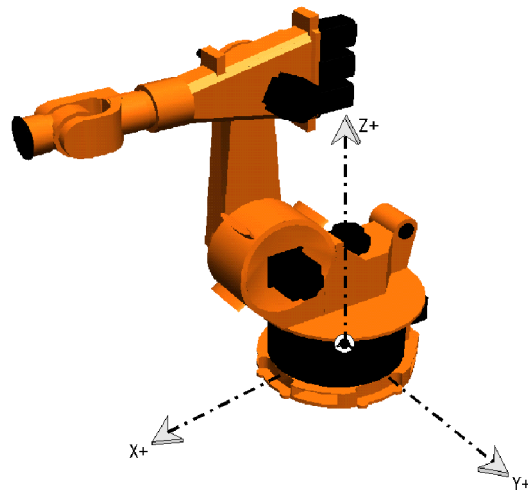

Position of ● operator



Information regarding the Space Mouse:
The World coordinate system corresponds with that of the Space Mouse if the operator (KCP) is standing directly in front of the robot in the position illustrated above. It is also possible to communicate a different operator (KCP) position to the system in order that the coordinate systems correspond with one another, thus ensuring that handling is kept as simple and safe as possible.

The following traversing keys/movements of the Space Mouse enable each axis to be moved individually:

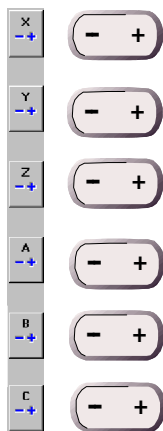

Manual traversing keys

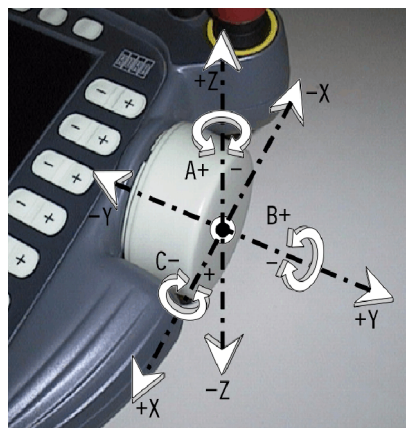

Space Mouse



Further information on the Space Mouse may be found in the chapter **[Manual traversing of the robot]**, in the section **[Moving the robot with the Space Mouse]**.

3.4 BASE coordinate system



The BASE coordinate system is a rectangular, cartesian coordinate system, the origin of which is located in an external tool. This could be a welding gun, for example. If you have selected this system as reference coordinate system, the robot moves parallel to the axes of the workpiece. The BASE coordinate system only moves in the case of a workpiece that is fixed to a mathematically coupled external kinematic system.

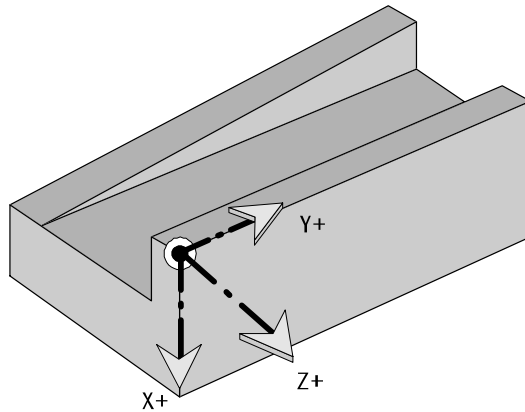

The following traversing keys/movements of the Space Mouse enable each axis to be moved individually:

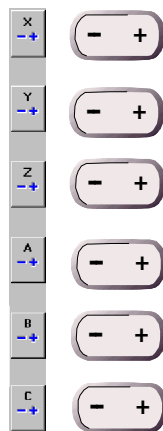

Manual traversing keys

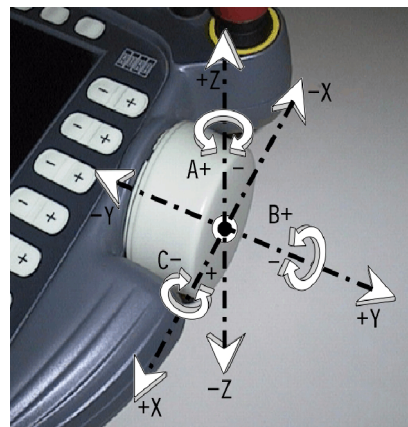

Space Mouse



On delivery, the origin of the BASE coordinate system is located in the base of the robot.

3.5 TOOL coordinate system



The TOOL coordinate system is a rectangular, cartesian coordinate system, the origin of which is located in the tool. This coordinate system is generally orientated in such a way that its X axis is identical to the working direction of the tool. The TOOL coordinate system constantly follows the movement of the tool.

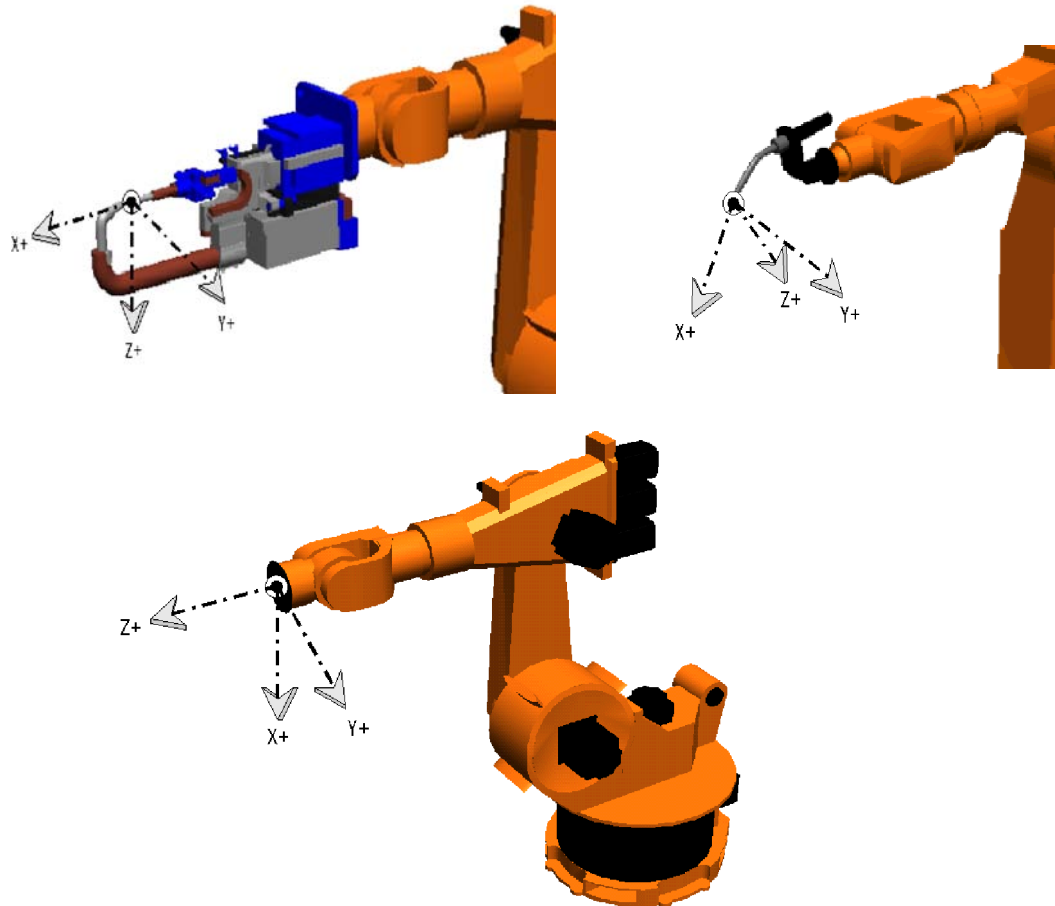

The following traversing keys/movements of the Space Mouse enable each axis to be moved individually:

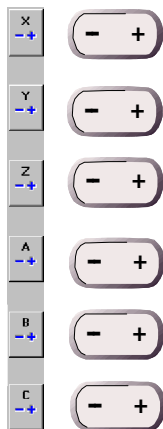

Manual traversing keys

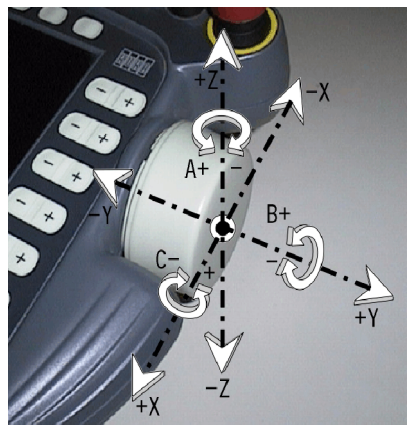

Space Mouse



On delivery, the origin of the TOOL coordinate system is located at the center of the robot flange.



4 Manual traversing of the robot

4.1 General

Manual traversing is used for manually controlled movement of the robot to teach destination points, for example, or to move the robot free after one of its axes has violated one of its software limit switches.

The robot has a total of six axes as standard, which are defined as follows:

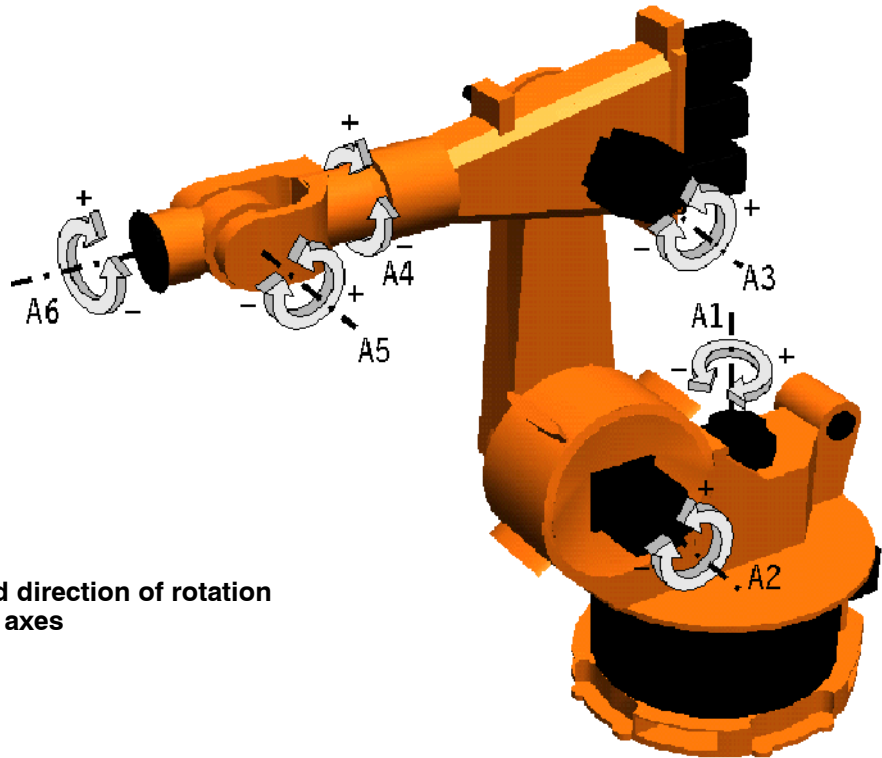

Overview:
Position and direction of rotation
of the robot axes

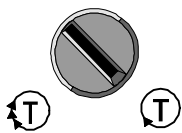

For manually traversing the robot, the mode selector switch must be set to “Jog mode” – T1 or T2. Manual traversing is not possible with the switch in the positions “Automatic” and “Automatic External”.

The current setting of the mode selector switch is displayed in the status line:



Further information on the operator control element “Mode selector switch” can be found in the chapter [The KUKA Control Panel KCP].



The robot can be manually traversed only if there is no EMERGENCY STOP situation.



If a robot axis runs against one of its software limit switches, it is immediately switched off. The robot can then be moved out of this position manually in the joint coordinate system. All the other axes remain unaffected.



Please note:

If one or more of the robot axes hits its end stop without being braked and at more than 20 cm/s (manual velocity set by the manufacturer), the buffer concerned must be replaced immediately.

If this happens to axis 1 of a wall-mounted robot, its rotating column must be replaced.

4.2 Selecting the traversing mode

The following traversing modes are available for manual traversing of the robot:



- **Manual traversing switched off**

Intended solely for program execution or operation in “Automatic” mode;



- **Moving the robot with the “Space Mouse”**

For simultaneous movement of 3 or 6 axes, depending on the setting of the degrees of freedom;



- **Moving the robot with the traversing keys**

In order to move each axis individually.

To make your selection, repeatedly press the status key “Traversing mode” until the symbol for the desired traversing mode appears in the status key bar.

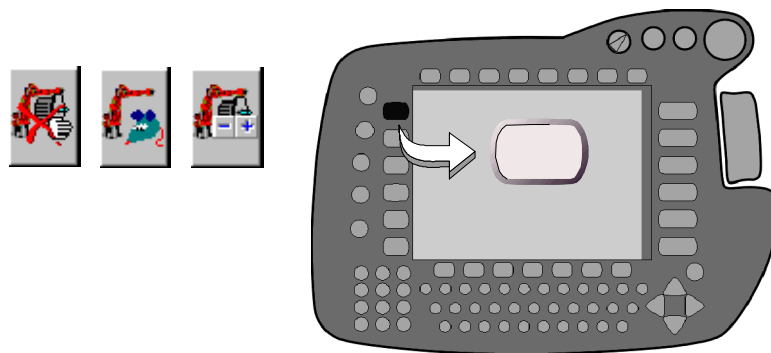

For the purposes of enhancing your overview of the robot movement, the positions of the axes can be shown in a status window. To do this, the menu key “Monitor” is pressed and one of the options in the submenu “Rob. Position” is selected.

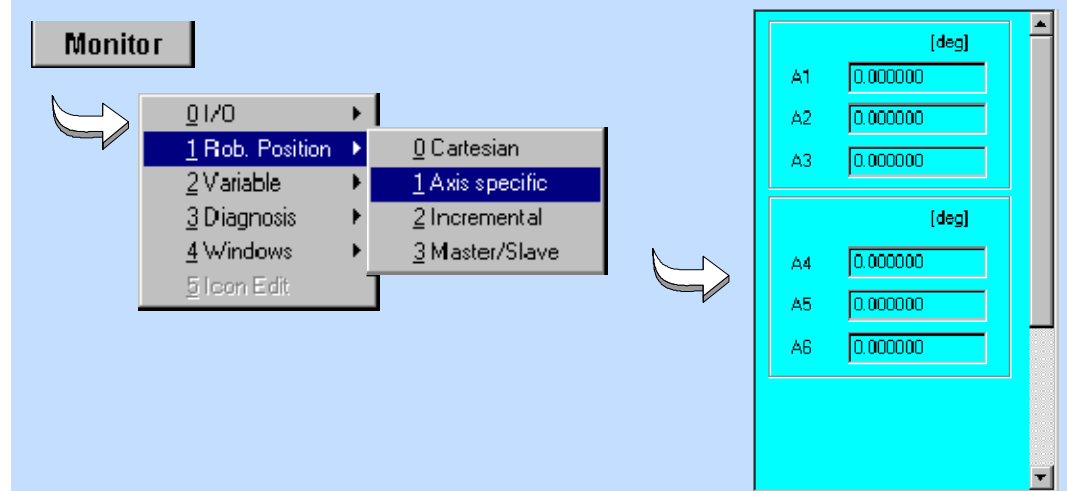

4.3 Selecting the kinematic system

The traversing keys can be used to move both the standard robot axes and external axes, as well as any external kinematic systems which have been configured. To select the desired axis or kinematic system, repeatedly press the status key shown below.

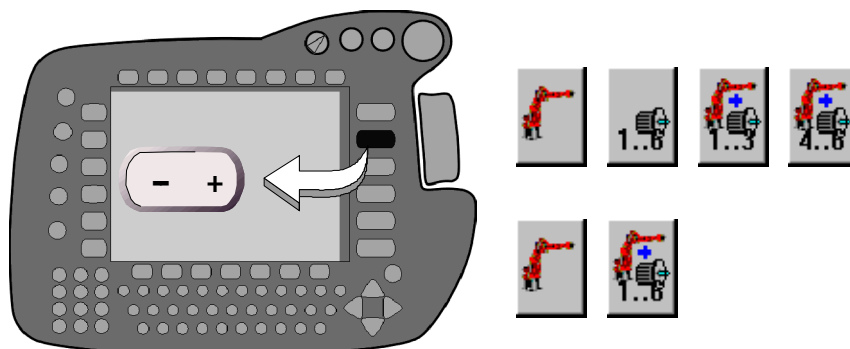

The type and number of options available depend on your system configuration.



First ensure that manual traversing with the traversing keys or Space Mouse is activated. Otherwise, moving the external axes will not be possible. Details can be found in Section 4.2.



- **Robot**
Only the 6 robot axes A1...A6 (joint coordinate system) or X,Y,Z,A,B,C (reference coordinate system) can be moved



- **External axes**
Here you can move only the external axes (E1...E6)



- **Robot and external axes**
The main axes of the robot (A1...A3 or X,Y,Z) and the first 3 external axes (E1...E3) can be moved



Here the main axes (A1...A3 or X,Y,Z) and the external axes (E4...E6) can be moved



If you move the robot using the Space Mouse (axes A1...A6 or X,Y,Z,A,B,C), you can move the external axes (E1...E6) using the status keys. To do so, keep the enabling switch held down.

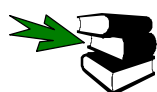

Further information about external axes can be found in the separate documentation [External Axes].

4.4 Selecting the coordinate system

After you have selected the Space Mouse or the traversing keys, you can now choose the reference coordinate system on which the robot movements are to be based. In manual traversing, the individual axes then move in relation to the system selected.

The following reference coordinate systems can be selected:



- **Joint coordinate system**

Each robot axis can be individually moved in positive or negative direction.



- **WORLD coordinate system**

A fixed, rectangular coordinate system which has its origin at the base of the robot.



- **BASE coordinate system**

Rectangular coordinate system, whose origin is located in the workpiece.



- **TOOL coordinate system**

Rectangular coordinate system, whose origin is located in the tool.



The robot moves in accordance with the reference coordinate system selected. This has the effect that the robot movements are different in, say, the TOOL coordinate system from those in the BASE coordinate system.



If the wrist axes A4 and A6 are in alignment (e.g. in the mastering position), axis A5 must first be moved in the joint coordinate system in order to avoid the error message “Command acceleration exceeded A4”.



In the extended wrist axis position (A4 and A6 in alignment), there is the danger that an external energy supply system (if present) may be wound around the wrist axis.

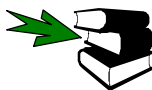

Further information on the extended wrist axis position can be found in the documentation [User Programming], in the chapter [Motion], section “Infinitely rotating axes”.



If the robot is moved through the extended position (axes A2 and A3 in a straight line), axis A3 may abruptly drop 15–20 cm before the command velocity is exceeded and the axis switched off.

To select the desired coordinate system, repeatedly press the status key on the KCP illustrated below until the symbol for the coordinate system illustrated above appears in the status key bar.

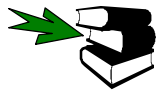
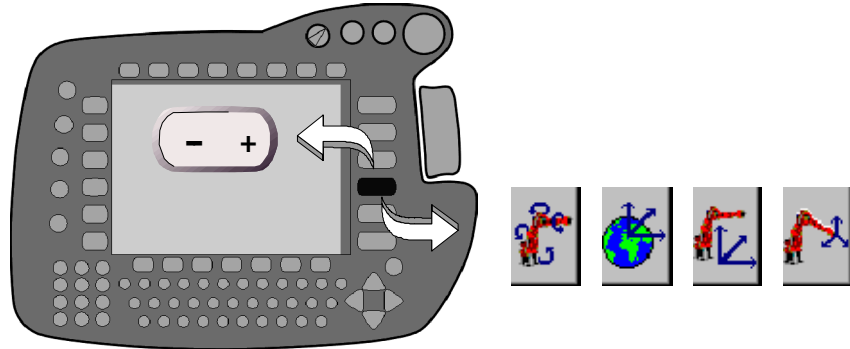

For further information on the subject “reference coordinate systems” please refer to the documentation **[Operator Control]**, chapter **[Coordinate systems]**.



As standard, when the robot is delivered, the BASE and TOOL coordinate systems are not calibrated.

If the BASE coordinate system (\$BASE) is not calibrated, it corresponds to the WORLD coordinate system which is usually situated in the base of the robot.

If the TOOL coordinate system (\$TOOL) is not calibrated, it is situated at the center of the robot flange.

4.5 Jog override (manual traversing velocity)

In some cases (e.g. moving to destination points during teaching) it is of vital importance to reduce the traversing velocity. Only in this way can points be addressed precisely and collisions with tools/workpieces be avoided.

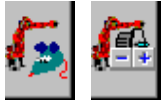

The “Jog override” function, which is only available in the “Manual traversing” mode, can be used for this purpose. The status key “Traversing mode” (at the top left of the display) must show the symbol “Space Mouse” or “Traversing keys”.



You can now alter the jog override setting by means of the “+/-” status key to the right of the symbol “Override” (at the bottom right of the display). The current setting is displayed both in the symbol and in the status line.

HOV=50%

With the Space Mouse, the velocity can be further decreased by reducing the deflection of the mouse (velocity proportional to the deflection).



In modes “T1” and “T2”, the Jog override can also be altered during program execution.



The Jog override increment can be increased. To do this you must activate the option “Jog-OV Steps” in the “Configure – Jogging” menu. The value is then no longer altered in increments of 1% but changes between 1, 3, 10, 30, 50, 75 and 100 per cent of the value specified in the machine data.

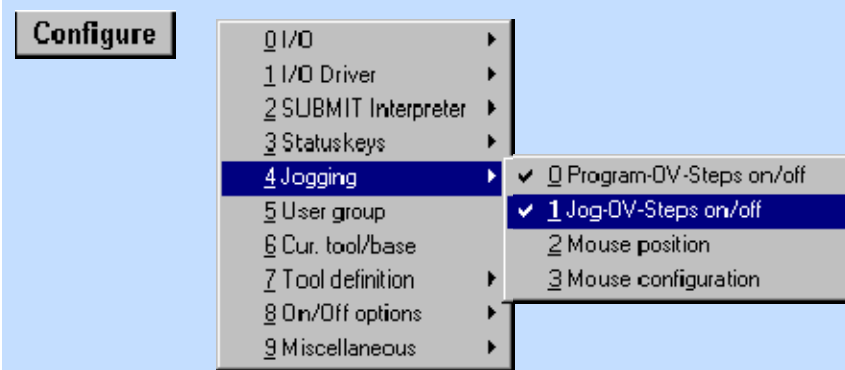

If you have selected the joint coordinate system as the reference coordinate system, the jog override refers to the specific axis.

If a rectangular coordinate system is set (e.g. WORLD coordinate system) the jog override refers to the axis with the longest trajectory (leading axis). The motions of all other axes are synchronized with the leading axis.

4.6 Moving the robot with the Space Mouse

4.6.1 General



If you have selected the Space Mouse as the operator control element using the status key "Traversing mode", you can now move the robot in 3 or 6 axes (degrees of freedom) at the same time. The Space Mouse is assigned a coordinate system that stays the same in all reference coordinate systems.



Please refer to the section **[Selecting the traversing mode]** for information on selecting this traversing mode.

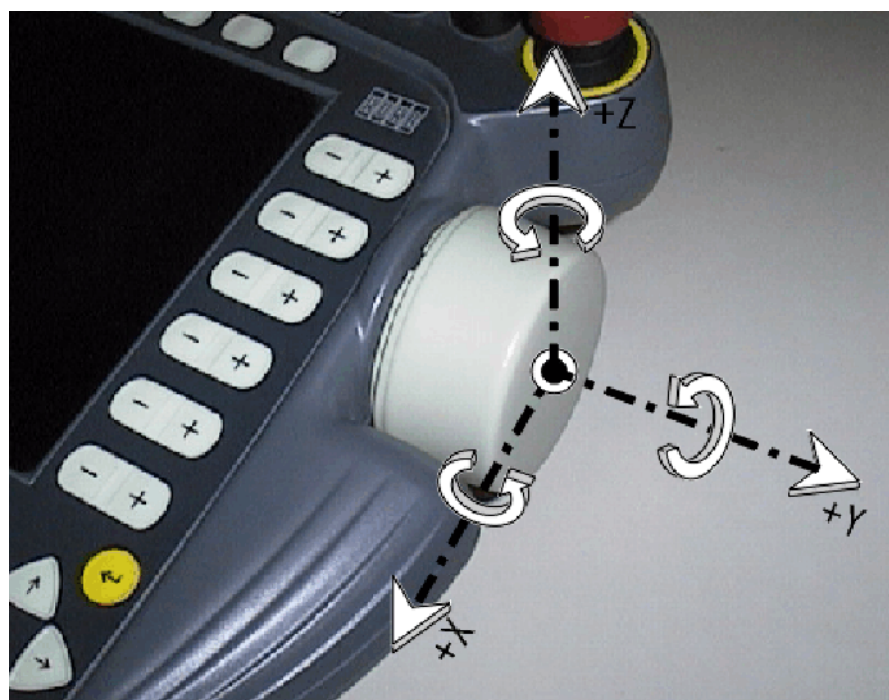

If you **pull** the Space Mouse towards you in the **positive X** direction, for example, the robot axes will likewise move in the positive direction in the reference coordinate system. This also applies to the Y and Z axes.

Turning the Space Mouse about its X axis, for example, likewise causes the tool center point to rotate about the X axis of the set reference coordinate system. This again applies equally to the Y and Z axes.



Please refer to the section **[Selecting the coordinate system]** for more information on coordinate systems.



It is only possible to move the robot manually if you first hold down one of the enabling switches (located on the back of the KCP) and then operate the Space Mouse. If either the enabling switch or the Space Mouse is released while the robot is moving, it is stopped immediately.

For robot motions in the world coordinate system, the function "Mouse position" is also available.

For certain applications, e.g. fine positioning or tool calibration, it is useful not to move the robot in 6 axes simultaneously. For this reason, the aids "Degrees of freedom" and "Dominant axis" are available to reduce the number.

4.6.2 Mouse position

In order to ensure intuitive operator control when traversing the robot using the Space Mouse, the operator can inform the controller of his position.

Configure This function is reached by pressing the menu key “Configure” and executing the option “Jogging” -> “Mouse position”.

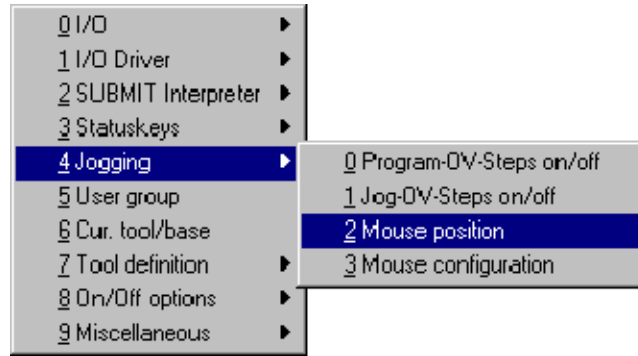

The default setting for the mouse position is 0 degrees (in the positive X direction the robot will move towards the operator). To ensure that the deflection of the Space Mouse corresponds to the motion direction, the operator should stand in front of the robot.

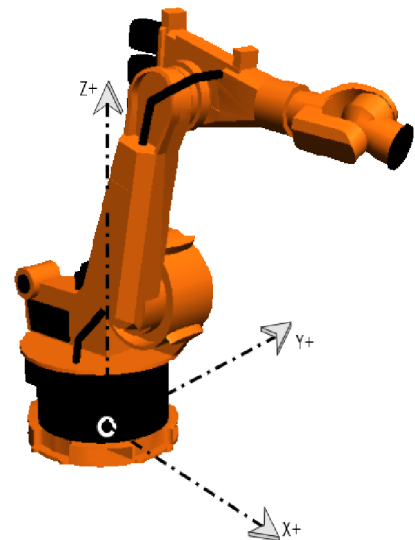
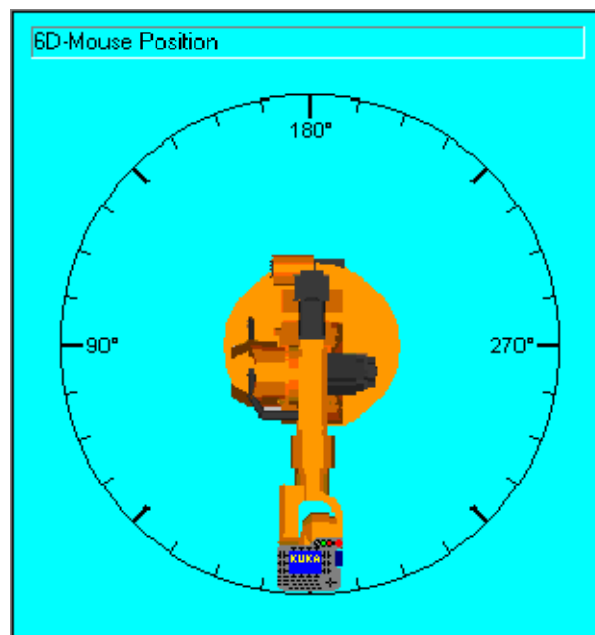

If the operator now moves to the left of the robot and wishes to again move the robot towards himself, he no longer has to rethink what he is doing. The mouse position is simply set to 90 degrees. This causes the world coordinate system to be rotated by 90 degrees in the robot controller.

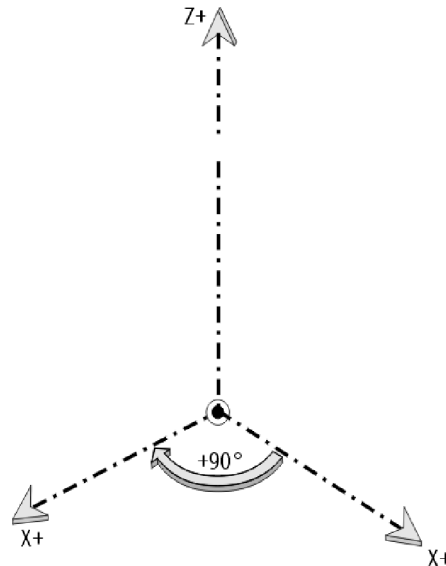

The same Space Mouse motion as before will once again move the robot towards the operator.

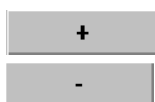
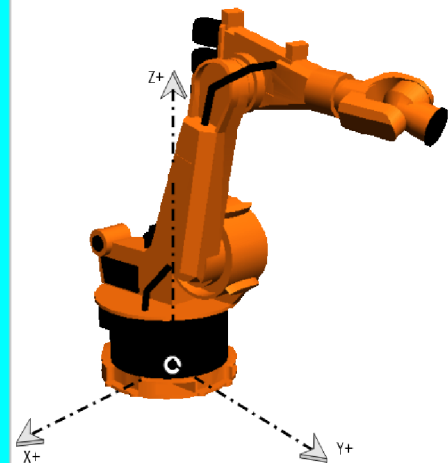
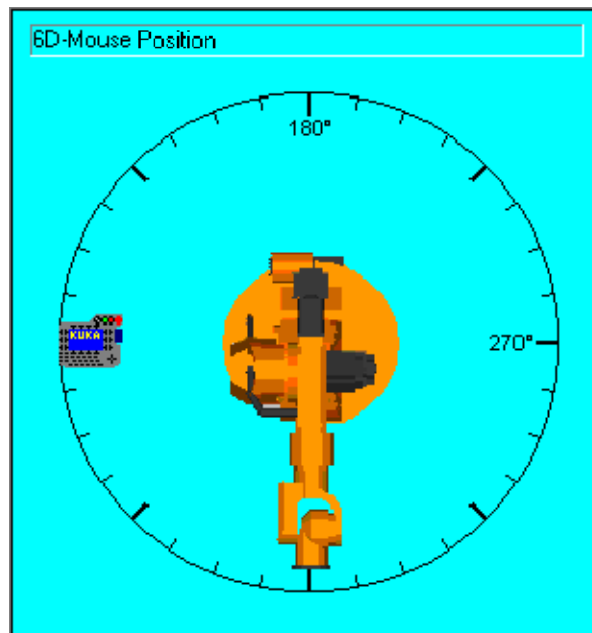

You can change the position of the 6D mouse by pressing the corresponding softkeys. Each time the softkey “+” is pressed, the world coordinate system is rotated an additional 45 degrees in a clockwise direction. The softkey “-” rotates the coordinate system in a counter-clockwise direction.

The KCP symbol in the status window also moves each time the softkey is pressed, and thus always indicates the current position.

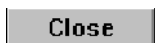

The softkey “Close” accepts the current mouse position and closes the status window.



When switching to “AUT” (Automatic) or “EXT” (Automatic External) mode, the mouse position is automatically reset to 0 degrees.

4 Manual traversing of the robot (continued)



Pressing the softkey “+” twice shifts the mouse position 90 degrees clockwise. The operator is standing to the left of the robot in this case.

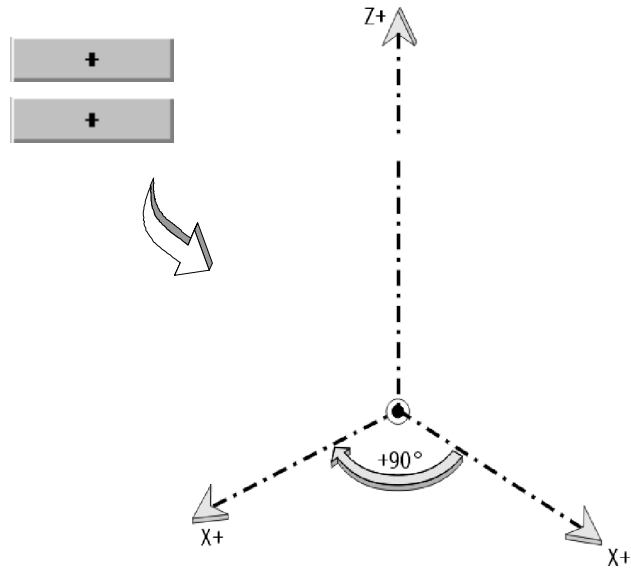

4.6.3 Degrees of freedom of the Space Mouse (Mouse configuration)

The number of axes which can be moved simultaneously using the Space Mouse can be limited. This is done using the function “Degrees of freedom”.

Configure

This function is reached by pressing the menu key “Configure” and executing the option “Jogging” -> “Mouse configuration”.

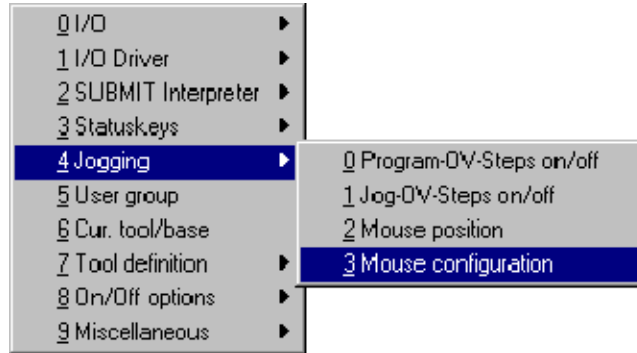

A status window opens in which you can set the degrees of freedom.

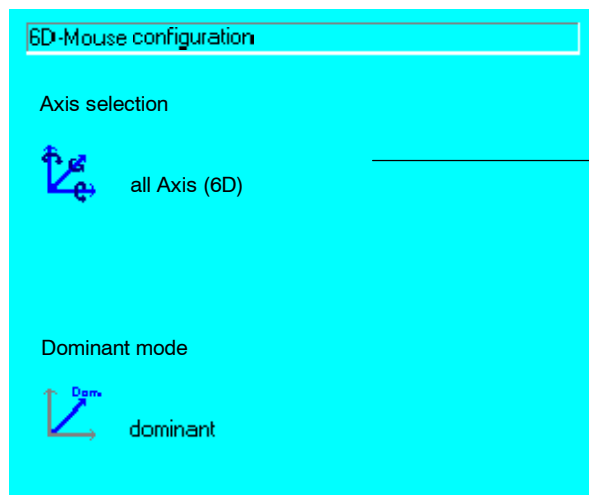

Degrees of freedom of the Space Mouse

A total of three options are available:

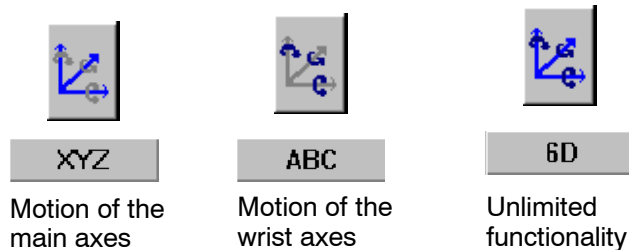

4.6.3.1 Motion of the main axes



XYZ

The functionality of the Space Mouse is here restricted to motion of the main axes A1, A2 and A3. Only **pulling** or **pushing** the Space Mouse, as shown in the figure below, moves the robot. How the robot moves depends on the reference coordinate system of the robot that has been set. Turning the Space Mouse has no effect on the robot.

Turning the Space Mouse about its coordinate axes therefore has no effect on the robot.

If you have selected a Cartesian (rectangular) coordinate system, you can only move the robot translationally in the X, Y and Z coordinate axes. Several axes usually move synchronously in this case. If, on the other hand, you have selected the joint (axis-specific) coordinate system, you can only move the robot axes A1, A2 and A3 directly.

Joint reference coordinate system:

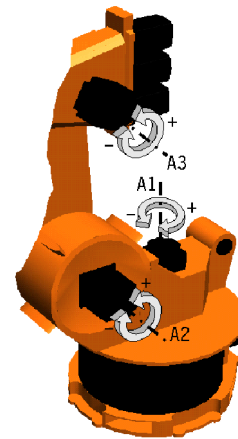
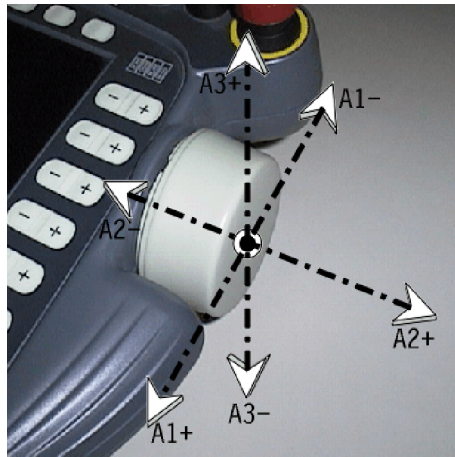

4.6.3.2 Motion of the main axes



ABC

The functionality of the Space Mouse is here restricted to motion of the wrist axes. Only **rotating** the Space Mouse, as shown in the figure below, moves the robot. Here too, the type of movement depends on the reference coordinate system of the robot that has been set.

Pulling and pushing the Space Mouse has no effect on the robot.

In a Cartesian coordinate system, you can only move the robot rotationally about the X, Y and Z coordinate axes. Several axes can also move simultaneously in this case too. If, on the other hand, you have selected the joint (axis-specific) coordinate system, you can only move the robot axes A4, A5 and A6 directly.

Joint reference coordinate system:

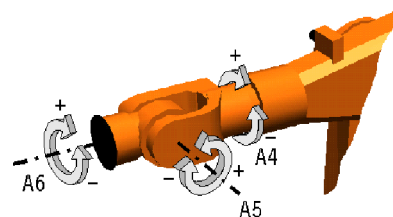
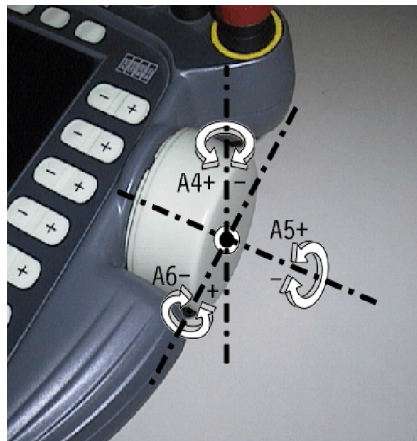

4.6.3.3 Unlimited functionality



6D

With this setting, all 6 axes of the robot can be moved. If a Cartesian coordinate system is selected, **pushing** or **pulling** the Space Mouse along its X, Y or Z axis causes the robot to be correspondingly moved along the X, Y or Z axis of the set reference coordinate system. **Rotating** the Space Mouse about its X, Y or Z axis similarly causes the tool center point to be correspondingly rotated about the X, Y or Z axis.

If you select the joint coordinate system, you can specifically move the robot axes A1 to A6: **Pushing** or **pulling** (translational motions) along the X, Y and Z coordinate axes of the Space Mouse moves the robot axes A1, A2 and A3. If, on the other hand, you **turn** the Space Mouse about its X, Y and Z coordinate axes, you can move the wrist (robot axes A4, A5 and A6).

Joint reference coordinate system:

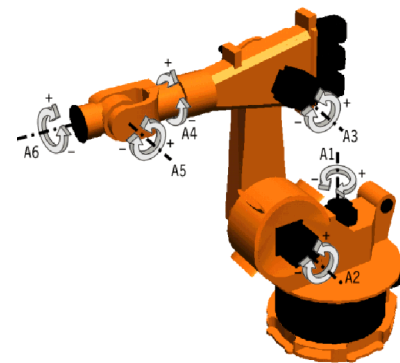
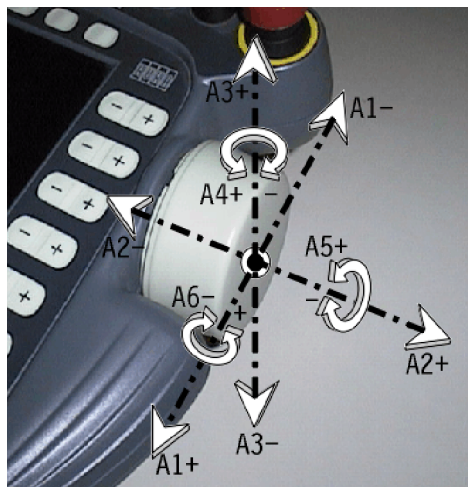

You can use the settings described above to reduce the number of degrees of freedom from 6 to 3, but it is not possible to move just one single axis with the Space Mouse.

It is, however, possible to define a so-called "dominant" axis in order to permit operation with only one axis if required.

4.6.4 Dominant axis of the Space Mouse (Mouse configuration)

For various applications, it is useful to limit the function of the Space Mouse to one robot axis, the so-called “dominant” axis. When this function is switched on, only the coordinate axis with the greatest deflection of the Space–Mouse is moved.

Configure This function is reached by pressing the menu key “Configure” and executing the option “Jogging” -> “Mouse configuration”.

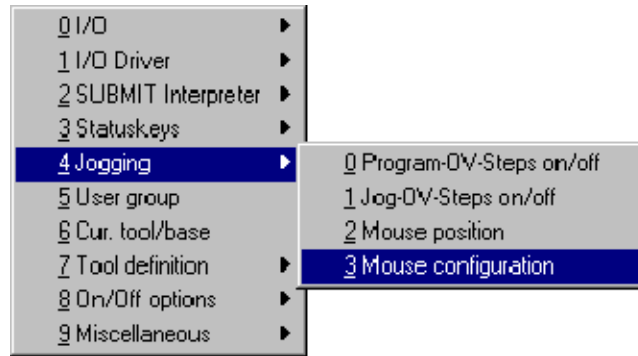

A status window opens in which you can specify whether only the dominant axis is moved.

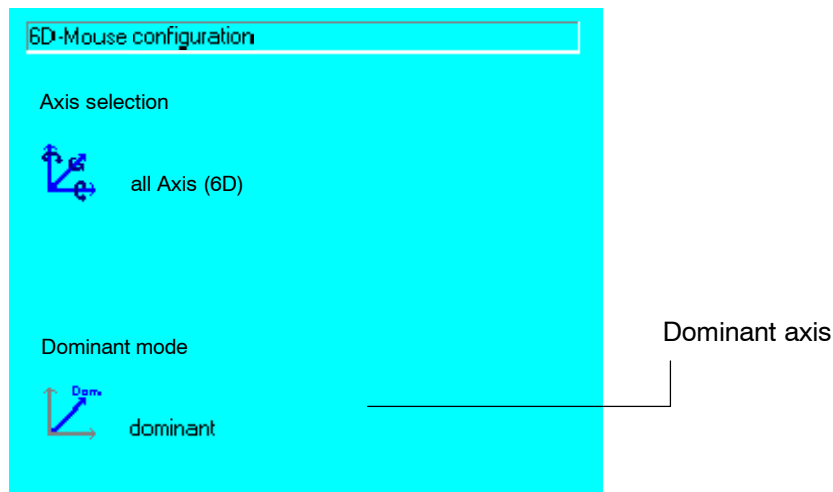

The command “Dominant axis” can also be switched on and off using the corresponding status key. This status key is only available in the traversing mode “Space Mouse”.

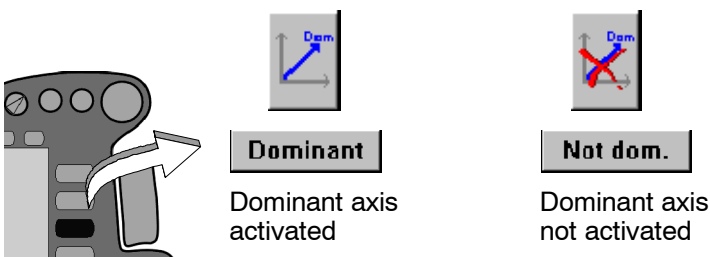

4.6.4.1 Dominant axis activated



For moving the robot, the coordinate axis of the Space Mouse that is **currently** given the greatest deflection is relevant.

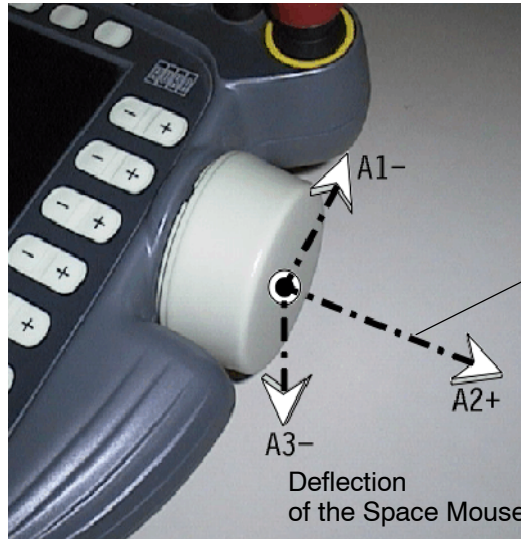

In this diagram, the relative deflections of the Space Mouse for axes A1-, A2+ and A3- are represented by different arrow lengths.

As can be seen, the deflection for A2+ is greatest in this example.

Axis 2 is thus the dominant axis, and only axis 2 is traversed.

As soon as another axis registers a greater deflection, this in turn becomes the dominant axis.

4.6.4.2 Dominant axis not activated



Either 3 or all 6 axes can be moved depending on the setting of the degrees of freedom. This is known as a so-called superposed motion. Manual traversing of 3 or 6 axes simultaneously should primarily be left to experienced users.

4.7 Moving the robot with the traversing keys



If, using the status key “Traversing mode”, you have selected the traversing keys as the input medium, you can move the robot in accordance with the set reference coordinate system by pressing the “+/-” status key.

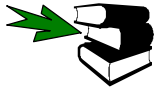

Please refer to the section [Selecting the traversing mode] for further information on selecting the traversing mode.

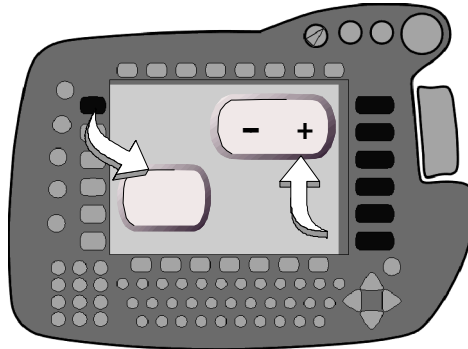

With some robot models, the user interface may vary slightly from the standard interface. With a palletizing robot in axis-specific manual traversing mode, for example, axes A4 and A5 are not available, and in Cartesian traversing mode, angles B and C are not available.

4.7.1 Joint coordinate system



If you have selected the **joint** (axis-specific) coordinate system, the main and wrist axes A1 to A6 will be displayed in the righthand status key bar as soon as you press one of the enabling switches on the rear of the KCP.

In the **joint** coordinate system, the traversing keys are assigned the axis designations depicted below. The arrows shown on the robot axes (A1 to A6) show the direction the axes will move when the “+” status key is pressed.

The axes are moved in the opposite direction (-) by pressing the side of the status keys marked “-”.

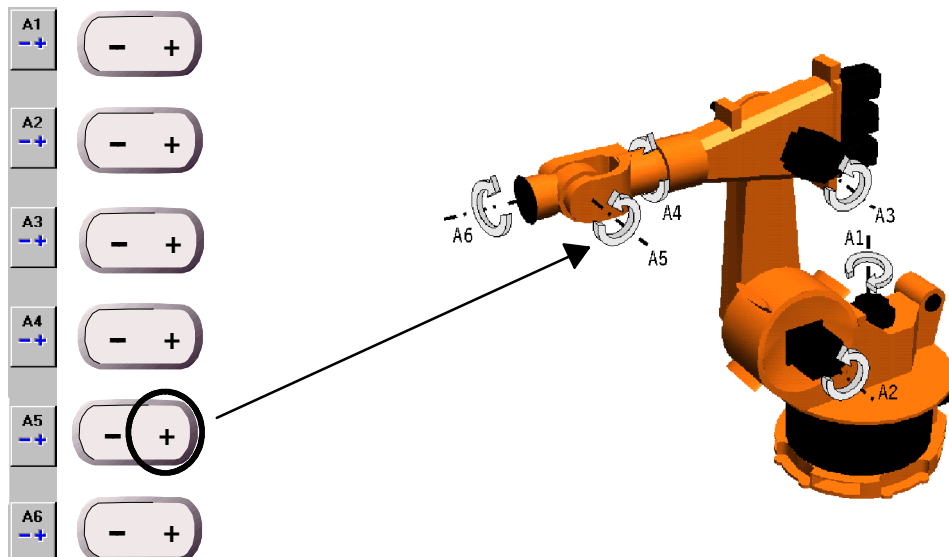

4.7.2 Coordinate systems TOOL, BASE, WORLD

If you have selected the “TOOL”, “BASE” or “WORLD” coordinate system, the main axes X, Y and Z, and the wrist axes A, B and C are displayed. Several axes are usually moved synchronously.

In the **world coordinate system**, the traversing keys are assigned the axis designations depicted below. Here, too, the arrows indicate the positive axis directions.

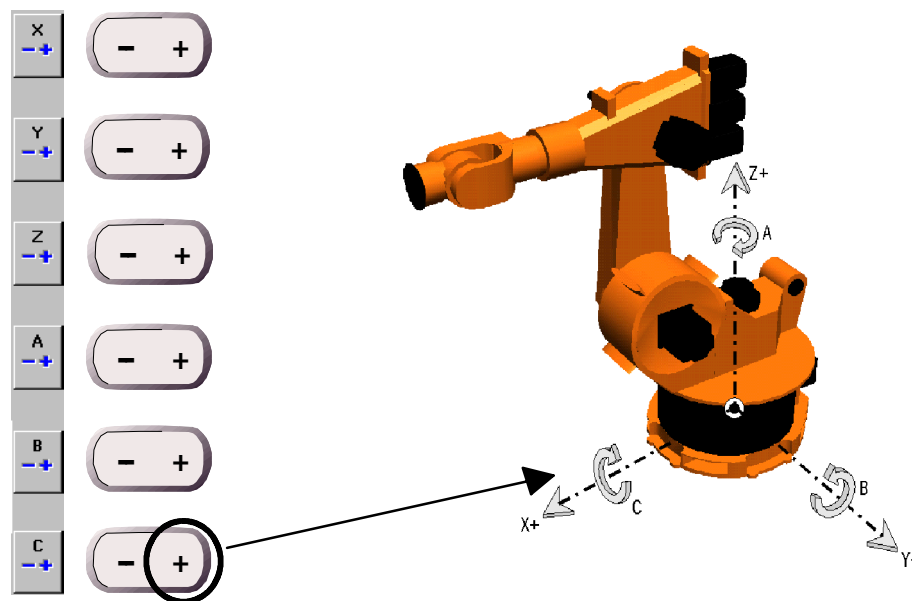

Please refer to the chapter **[Coordinate systems]** for detailed information on the reference coordinate systems.



It is only possible to move the robot manually if you first hold down one of the enabling switches (located on the back of the KCP) and then press the desired traversing key. If either the enabling switch or the traversing key is released, the robot is stopped immediately.

4.7.3 Incremental manual traversing

A motion command can be executed step by step using incremental manual traversing. In the event of an error it enables the user to move the robot a defined distance or orientation away from the component. The robot can then be moved step by step back to the previous position.



The positioning of equidistant points is significantly accelerated using this function. This option can also be used when mastering with the dial gauge.

The following increments can be set as standard:



Incremental manual traversing switched off



Increment set to 100 mm linear (X, Y, Z) or 10 degrees orientation (A, B, C)



Increment set to 10 mm linear (X, Y, Z) or 3 degrees orientation (A, B, C)

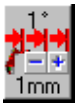

Increment set to 1 mm linear (X, Y, Z) or 1 degree orientation (A, B, C)



Increment set to 0.1 mm linear (X, Y, Z) or 0.005 degrees orientation (A, B, C)



To toggle the increment, press the corresponding status key on the righthand side of the display. The “-” key toggles to the next value down while the “+” key toggles to the next value up.



Incremental manual traversing is only available if manual traversing with the traversing keys has been activated.

To move the robot manually, you must hold down an enabling switch and then press the traversing key of the desired axis. Once the set increment has been reached, the status key must be released and pressed again.

The robot keeps moving as long as the jog key remains pressed, and stops by itself after the preset distance or number of degrees has been reached.

In the case of an interruption, e.g. Emergency Stop, change of operating mode, releasing the jog key or enabling switch, the robot stops. This terminates the incremental motion that has been started.



The increments are executed relative to the coordinate system selected.



5 Navigator

5.1 General

The Navigator is a so-called file manager which the operator can use to “navigate” through the drives and directory structures. The Navigator can be used to create, select, copy, save, delete and open files.

After the controller has run up, the KCP displays the following screenshot:

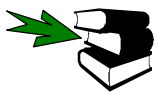
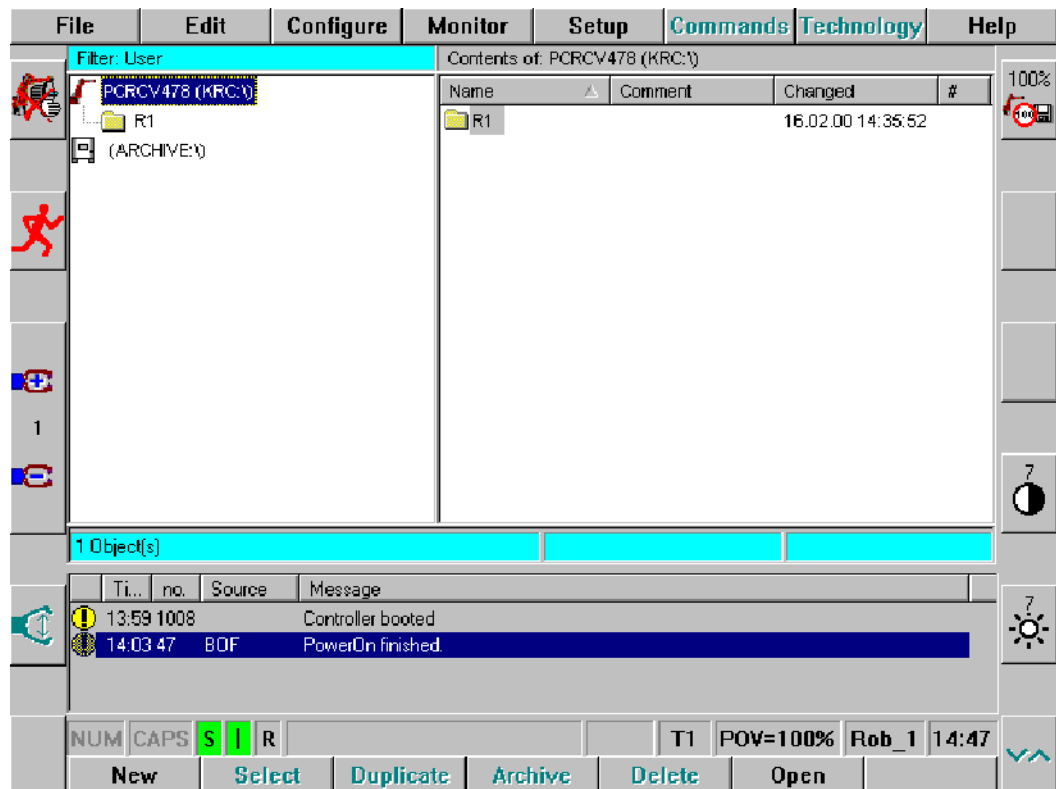

The meaning of the symbols, icons and particular font conventions is explained in the documentation **[Introduction]** in the chapter **[About this documentation]**.

5.2 Graphical user interface





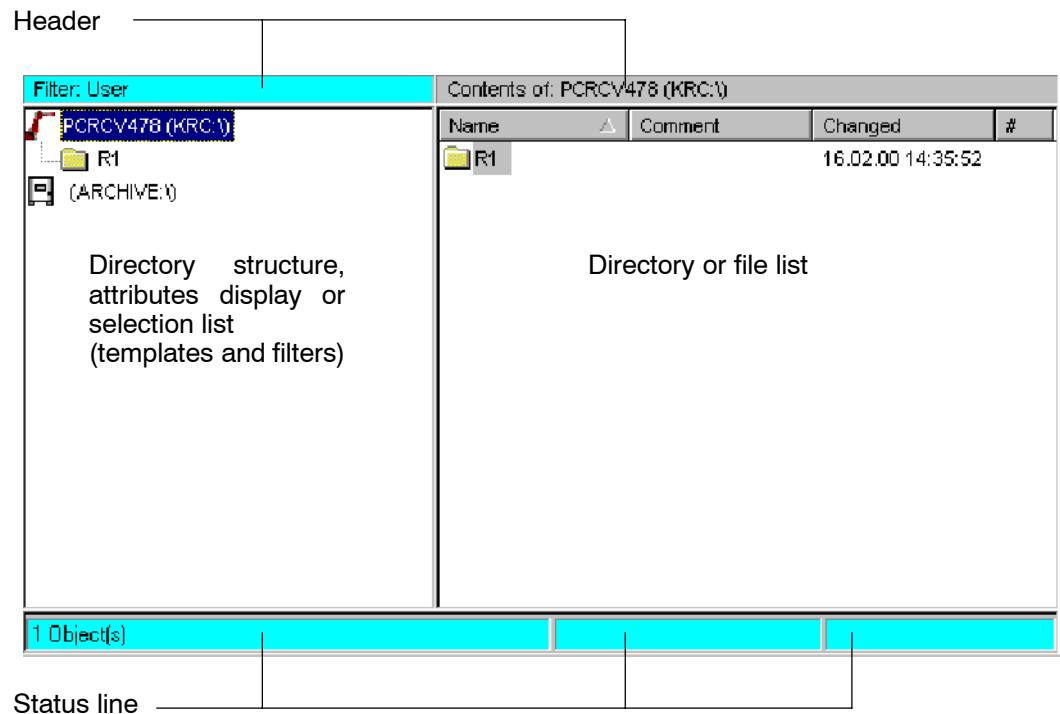

5.2.1 Fundamentals

The Navigator consists of the following four areas:















The following icons and symbols are used in the Navigator:

Drives

Symbol	Type	Default path
	Robot	KRC:\
	Floppy disk	A:\
	Hard disk *1	e.g. "Kukadisk (C:\)" or "Kukadata (D:\)"
	CD-ROM *1	E:\
	Mapped network drive *1	F:\ , G:\ , ...
	Backup drive	Archive:\

*1: In the default setting, these symbols are not shown below the user group "Expert"
 *2: If a network connection fails during operation, the Navigator is blocked by the operating system until the network error is detected. Operator actions (e.g. select/open program) are not possible during this time

Directories and files

Symbol	Type	Meaning
	Directory	Normal directory
	Directory open	Open subdirectory
	Archive	ZIP file (compressed directory)
	Read directory	The contents of the subdirectory are being read
	Module	Program at user level (*.src, *.dat, *.sub)
	Module containing errors	Program at user level which must be corrected before being run in the editor
	Src file *1	Program file at expert level
	Src file *1	Subprogram at expert level
	Src file containing errors *1	Program file at expert level which must be corrected before being run in the editor
	Dat file *1	Data list at expert level
	Dat file containing errors *1	Data list containing errors
	ASCII file *1	File that can be read using any editor
	Other files *1	Binary files which cannot be read in the text editor
*1: These symbols are not shown below the user group "Expert"		

5.2.2 Header

The left side of the header shows the filter or the templates that are available for selection. The right side shows the directory and/or file path.

Filter



↑
The current filter setting is displayed above the directory structure.

In expert mode, the filter can be set to default to “Modules” or “Detail view”.

↑
The current drive or directory is displayed in the directory or file list.



The filter setting cannot be changed below the user group “Expert”.

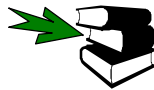

Further information about the “filter” can be found in Section 5.2.3.3.

Information on the “Expert level” can be found in the **Programming Handbook** in the documentation **[Configuration]**, chapter **[Configuring the system]**, section **“User group”**.

Template

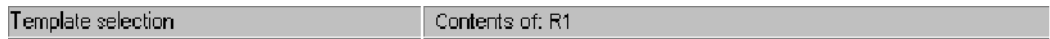

↑
The template selection is displayed above the directory structure.

This selection is only available at Expert level.

↑
The current drive or directory is displayed in the directory or file list.

5.2.3 Directory structure, attributes display, selection list

5.2.3.1 Directory structure

By default, the Navigator displays the directory structure of the current drives or directories.

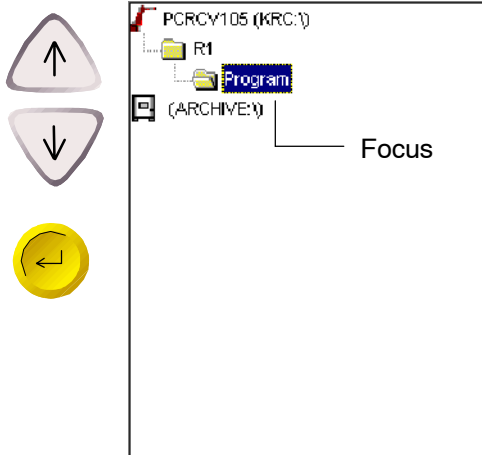

The current directory structure is normally shown on the left-hand side of the Navigator. This display varies according to the filter that has been set. (More detailed information on this can be found in Section 5.2.3.3.)

The contents of the drive or directory highlighted in color are then displayed as a file list on the right-hand side of the Navigator.

To select a drive or directory, move the focus to the desired symbol using the “↑” or “↓” arrow key.

To open or close a directory level, press the Enter key.

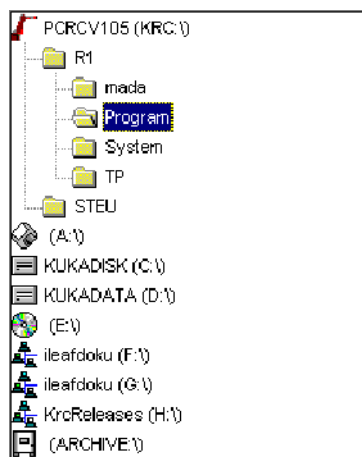

Further drives and directories are available at expert level.

Here too you can use the “↑”, “↓” arrow keys or the Enter key.

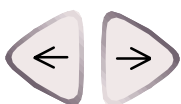

To switch between the directory structure and the file list, use the “←” or “→” arrow key.

5.2.3.2 Attributes display

The attributes display is opened by first selecting a file or folder.



Name	Comment	Changed	#
Program		16.02.00 14:35:52	
cell	HANDLER ON E...	07.02.00 10:33:12	
prog_01	TESTPROGRAMM	07.02.00 10:33:12	3

File

Then select the menu key “File” and the option “Attributes”.

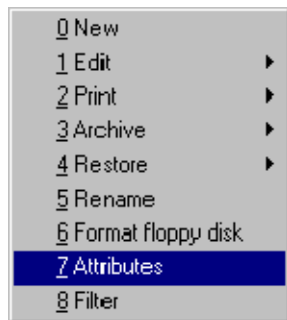

0 New
1 Edit
2 Print
3 Archive
4 Restore
5 Rename
6 Format floppy disk
7 Attributes
8 Filter

This shows further information regarding the file or directory. Several of these options can be changed.



The arrow keys “↓” and “↑” can be used to move the focus to an input box. You can then enter text or, using the space-bar, select an option.

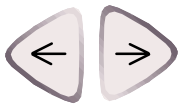

To move the cursor within an input box, use the “→” or “←” arrow keys. On the “User data” page, you can access the parameter values directly by pressing one of these keys.

Tab+

The softkey “Tab+” or the Tab key on the numeric keypad can be used to switch between the “General”, “Module info” and “User data” tabs. If you want to use the numeric keypad, the “NUM” display in the status line must be switched off. If this is not already the case, press the NUM key next to the numeric keypad.

NUM

Using the softkeys “OK” or “Cancel”, you can confirm the changes made or cancel the action.



Tab +					OK	Cancel
--------------	--	--	--	--	-----------	---------------

Alternatively, you can use the Enter or ESC keys.



General

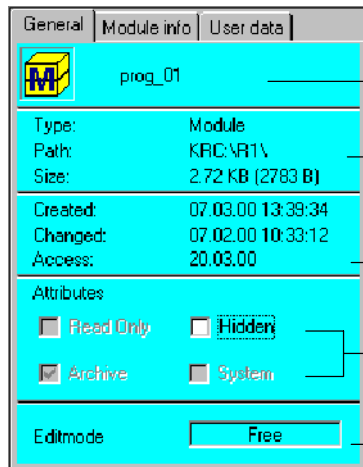

The name of the selected file (in this case a module comprising one “src” and one “dat” file)

Information about the file type (“Dir”, “Archive”, “Bin”, “Text”, “Module”, “VirtualDir” und “Unknown”), its path and the total amount of memory occupied

Date and time of file creation, change and most recent access

Display of the Windows file attributes which can be changed. More detailed information about this can be found in Section 5.2.4.

The current edit mode (“Free”, “FullEdit”, “ProKor” or “ReadOnly”)

Module info

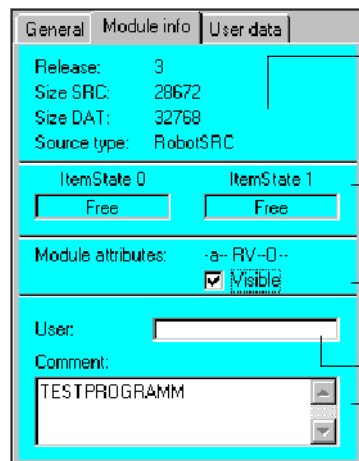

Information about the release, the “src” and “dat” files and the file type (“RobotSRC”, “SubmitSub” or “None”)

Status of the file in the Submit interpreter “State 0” and in the robot interpreter “State 1” (possibilities: “Unknown”, “Free”, “Selected” or “Active”)

Switching the kernel system attribute “Visibility”. More detailed information about this can be found in Section 5.2.4.

User name, max. 30 characters

Additional comment which can be scrolled using the “↓” and “↑” arrow keys if required

User data

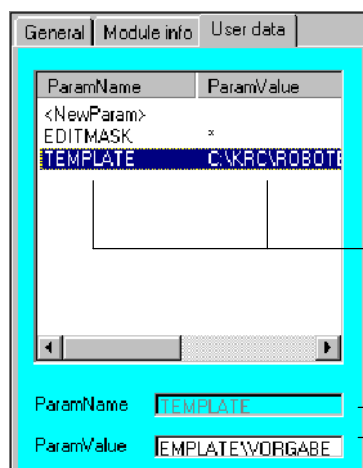

Any desired additional information can be anchored in KRL modules. This could be information about the version or the template name, for example.

Parameter “Template” and associated information

Name of the parameter

Associated parameter values

5.2.3.3 Selection list

At present, “Filter” and “Templates” are available in selection lists.

Filter

The menu command “Filter”, which is only available at expert level, opens a window and offers a choice of the following filter types:

FilterName	FilterComment
Detail	All files
Module	Modules

This setting affects the output in the file window



The appearance of the file list changes depending on the filter that is set.

Name	Ext...	Comment
mada		
Program		
System		
TP		
cell		HANDLER ON EX...
prog_01		TESTPROGRAMM
prog_02		START_APPL- 1
prog_03		START_APPL-2
test		TEST

Filter “Module”

Name	Ext...	Comment
mada		
Program		
System		
TP		
cell	src	HANDLER ON EX...
prog_01	src	TESTPROGRAMM
prog_01	dat	TESTPROGRAMM
prog_02	src	START_APPL- 1
prog_02	dat	START_APPL- 1
prog_03	src	START_APPL-2
prog_03	dat	START_APPL-2
test	src	TEST
test	dat	TEST

Filter “Detail”



The arrow keys “↓” and “↑” can be used to move the focus to the desired filter.

You can use the softkey bar to switch on the selected filter or cancel the action.



Template

At expert level, the softkey instruction “New” opens a window and offers one of the following templates depending on the directory selected:

Filename	Filter comment
Cell	Automatik extern dispatcher
Expert	Expert module
Expert Submit	Expert submit
Function	Function
Modul	Module
Submit	User submit

Which of the templates shown here will be offered depends on which directory the program is to be created in. For example, a CELL program can only be created in the directories “R1” and “Program”.

Here again you have the option of accepting the relevant setting or cancelling the action.

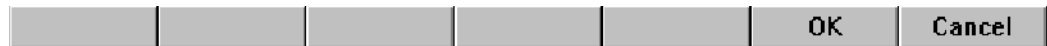

5.2.4 Directory and file list

The contents of the current drive or directory are displayed as a file list on the right-hand side of the Navigator.



Name	Ext...	Comment	Attributes
inada			---h
Program			----
System			---h
TP			---h
cell		HANDLER ON EX...	-a- RV--O--
prog_01		TESTPROGRAMM	-a- RV--O--
prog_02		START_APPL- 1	-a- RV--O--
prog_03		START_APPL-2	-a- RV-----
test		TEST	-a- RV-----

To select a directory or file, move the focus to the desired symbol using the “↑” or “↓” arrow key.

To open or close a directory level, press the Enter key.



At the expert level, the display of the file list can be influenced through the use of the filter function. Details can be found in Section 5.2.3.3.

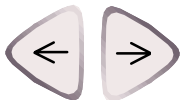

To switch between the directory structure and the file list, use the “←” or “→” arrow key.



The space-bar can be used to select several files permanently or to cancel selections.

Name	Comment	Changed	#
Program		16.02.00 14:35:52	
cell	HANDLER ON E...	07.02.00 10:33:12	
prog_01	TESTPROGRAMM	07.02.00 10:33:12	3
prog_02	START_APPL- 1	07.02.00 14:51:34	2
prog_03	START_APPL-2	07.02.00 14:43:22	1
prog_04		09.02.00 14:41:18	15
test	TEST	07.02.00 14:41:52	1

To do so, move the focus to the desired file using the “↓” or “↑” arrow key and press the space-bar. The file in question is now selected.

Press the space-bar again and the selection is cancelled.

Alternatively, more than one file can be selected using the key combination “Shift” + “↓” or “Shift” + “↑”.

The ESC key cancels the selection of all the files highlighted.

Using the filter option “Detail” at expert level, the same file list has the following appearance:

Name	Ext...	Comment	Attributes
System			--h
TP			--h
cell	src	HANDLER ON EX...	-a- RV--O-
prog_01	src	TESTPROGRAMM	-a- RV--O-
prog_01	dat	TESTPROGRAMM	-a- RV--O-
prog_02	src	START_APPL-1	-a- RV--O-
prog_02	dat	START_APPL-1	-a- RV--O-
prog_03	src	START_APPL-2	-a- RV----
prog_03	dat	START_APPL-2	-a- RV----
prog_04	src		-a- RV---E-
prog_04	dat		-a- RV---E-
test	src	TEST	-a- RV----
test	dat	TEST	-a- RV----

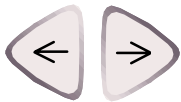

The contents of the file window can be moved left or right using the keys “Alt” + “←” or “Alt” + “→” in order to enable the desired information to be seen. Alternatively, instead of the “Alt” key you can use the “Shift” key.

5.2.4.1 Pop-up menu

For each selected object (e.g. program list or data list, etc.) a pop-up menu can be opened as an alternative to the pull-down menus and softkeys. Only those commands which can actually be executed at a given moment are available for selection.

There are three different ways of opening the menu:

- Pressing the “→” arrow key;
- Pressing the right mouse button (if a computer mouse is connected);
- Pressing the application key (if a corresponding keyboard is connected to the system).

The pop-up menu, which may look like the example below, is then opened:

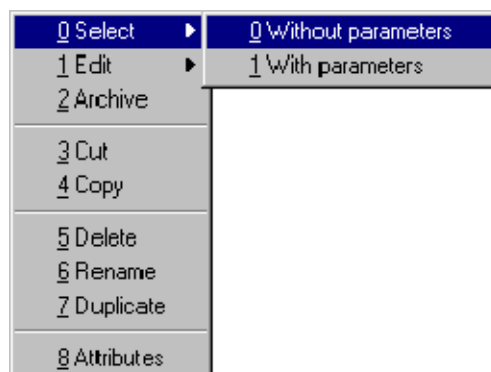

Move the focus to the previous/next menu item using the “↑” and “↓” arrow keys. You can open a submenu using “→” or the Enter key and close it again using “←” or the ESC key.

Alternatively, you can select a command by pressing the corresponding number on the numeric keypad. The “NUM” display must be activated in order to do this. The numbers preceding the individual commands are fixed, i.e. the commands are not dynamically renumbered. Thus the experienced user need only remember the numbers relevant to him.



In some circumstances, the pop-up menu cannot be opened. This is the case, for example, when the attributes display is open.



The pop-up menu can also be used in conjunction with multiple directories or files selected at the same time.

All the menu items that may appear in the pop-up menu are listed below:

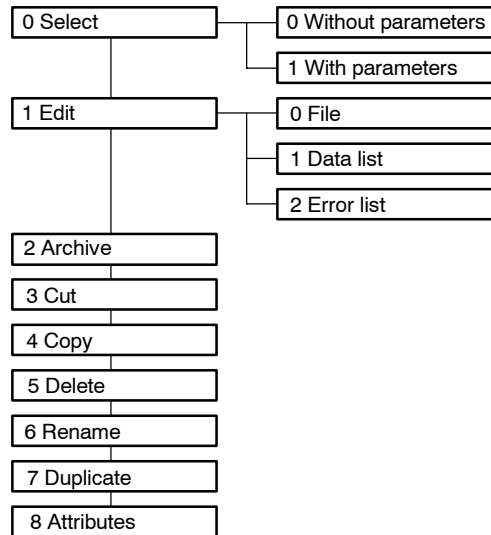

5.2.4.2 Additional information

The following additional information is available to the operator:

Name	Ext...	Comment	Attributes	Size:	#	Changed	Created
meda			--h			12.04.00 14:40:28	12.04.00 14:40:29
Program			---			12.04.00 14:40:10	12.04.00 14:40:11
System			--h			12.04.00 14:40:10	12.04.00 14:40:11
TP			--h			12.04.00 14:40:12	12.04.00 14:40:13
cell	src	HANDLER ON EX...	-a--RV--O--	2 KB	1	20.03.00 18:25:00	16.02.00 14:35:53
prog_01	src	TESTPROGRAMM	-a--RV--O--	3 KB	4	12.04.00 14:50:18	12.04.00 14:50:19
prog_01	dat	TESTPROGRAMM	-a--RV--O--	3 KB	4	12.04.00 14:50:30	12.04.00 14:50:31
prog_02	src	START_APPL- 1	-a--RV--O--	4 KB	3	12.04.00 15:37:44	12.04.00 14:50:21
prog_02	dat	START_APPL- 1	-a--RV--O--	3 KB	3	12.04.00 15:37:44	12.04.00 14:50:31
prog_03	src	START_APPL-2	-a--RV----	3 KB	1	12.04.00 14:50:20	12.04.00 14:50:20
prog_03	dat	START_APPL-2	-a--RV----	2 KB	1	12.04.00 14:50:30	12.04.00 14:50:31
prog_04	src		-a--RV--E-	4 KB	15	09.02.00 15:41:18	12.04.00 14:50:21
prog_04	dat		-a--RV--E-	3 KB	15	09.02.00 15:41:18	12.04.00 14:50:32

The title bar gives details about the type of information displayed. This information can also be accessed and, to a certain extent, changed using the menu command “File” -> “Properties”.

Name	Directory or file name
Dat...	File extension, e.g. "SRC", "SUB", "UPG" etc.
Comment	The first 10...15 characters of the comment
Attribute	The existing Windows 95 and kernel system attributes
Size:	File size in kilobytes
#	Number of changes made to the file
Changed	Date and time of the last change
Created:	Creation date including time

5.2.4.3 Windows 95 and kernel system attributes

The "Windows 95" operating system uses the following file attributes:



Attribute	Description	Meaning
r	Read only	File can only be read, not deleted
a	Archive	An attribute used, for example, by backup programs to decide whether or not a file should be saved
h	Hidden	The file is, by default, not displayed
s	System	This system file is necessary for the correct functioning of Windows 95 A number of important KRL files also have this attribute

The kernel system uses the following attributes:

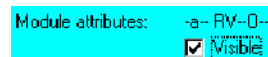

Attribute	Description	Meaning
R	Read	File can only be read, not deleted
V	Visible	This file is visible and is displayed in the sequence window
\$	Predefined	System file
P	Parent	The program has been selected since the controller was last run up
O	Old father	This file had already been selected once before the controller was last run up
E	Error	File contains errors; it must be corrected in the editor before it can be selected

5.2.5 Status line

Information about the number of files, their size, path, progress and other status messages are displayed in the status line of the Navigator. The appearance of the status line depends on the function called.

Here are several examples showing the possible appearance of the status line:

Contents display (turquoise)



Selection information (turquoise)



Action information (turquoise)

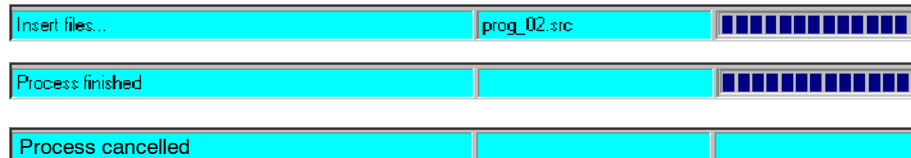

User dialog (yellow)



User entries (green)



These are confirmed with the Enter key or cancelled by pressing the ESC key.

Request for confirmation (gray)



When a request for confirmation is made, a corresponding line is generated, which must be answered via the softkey bar.

5.2.6 Error display

This option is used for error diagnosis and elimination. When the contents of a directory are read, the program or module, etc., is checked for syntax errors. If any are found, the files containing errors are displayed accordingly.

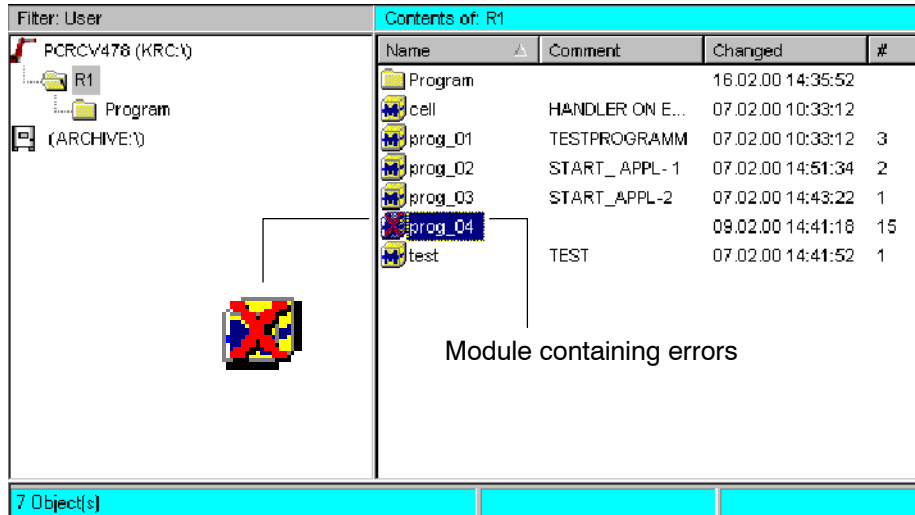

If the focus is moved to a file marked as containing errors, the appearance of the softkey bar changes as follows:



5.2.6.1 Error list

This softkey opens the error display.

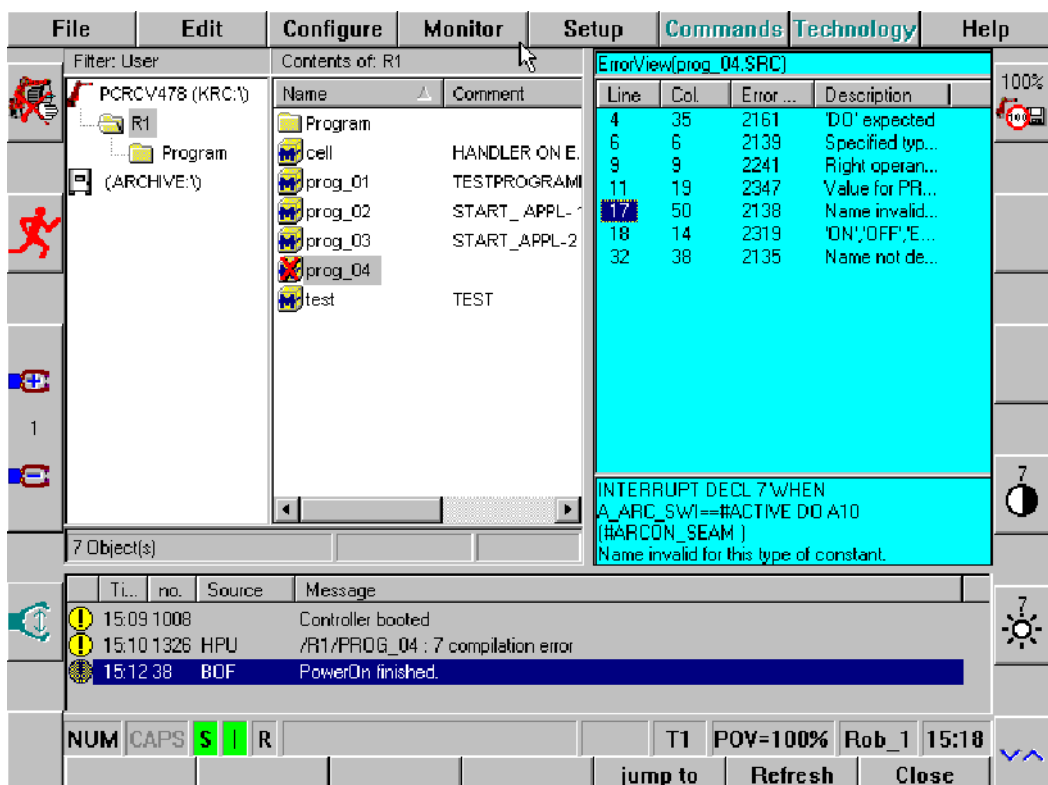



Additional information concerning the errors that have occurred is listed in the error list.

The screenshot shows the ErrorView window for 'prog_04.SRC'. The window title is 'ErrorView(prog_04.SRC)'. It contains a table with columns: Line, Col, Error..., and Description. The table lists several errors, with line 17 selected. Below the table, the source code for line 17 is shown: 'Name invalid for this type of constant.' To the left of the window are two arrow keys: an upward-pointing arrow and a downward-pointing arrow.

Line	Col	Error...	Description
4	35	2161	'DD' expected
6	6	2139	Specified typ...
9	9	2241	Right operan...
11	19	2347	Value for PR...
17	50	2138	Name invalid...
18	14	2319	'ON','OFF','E...
32	38	2135	Name not de...

Annotations on the right side of the screenshot:

- Title bar with the name of the file
- Short description
- Error number
- Line and column in which the error occurs
- Source text line in which the error occurs
- Error description

The arrow keys "↑" and "↓" can be used to select the desired error.

The following commands are available in the softkey bar:



jump to

This command opens the editor on the left-hand side.

The screenshot shows the KUKA control interface. The top menu bar includes: File, Program, Configure, Monitor, Setup, Commands, Technology, Help. The main area is split into two panes. The left pane shows a program listing with line numbers 1 through 10. The right pane shows the ErrorView window for 'prog_04.SRC' with the same error table as in the previous screenshot. Below the panes, there is a status bar showing the current file path and line/column: 'KRC:\R1\PROG_04.SRC Ln 1, Col 3'. At the bottom, there is a log window with the following entries:

Ti...	no.	Source	Message
15:09	1008	Controller	booted
15:10	1326	HPU	/R1/PROG_04 : 7 compilation error
15:12	38	BOF	PowerOn finished.
15:21	8	UserMode	User group: Expert

The bottom status bar includes: NUM, CAPS, S, I, R, T1, POV=100%, Rob_1, 15:22, Change, Motion, Logic, Last Cmd., Close, NAVIGATOR.



So that the line numbers in the error list correspond to those in the editor, the options “All FOLDS op” and “Detail view” must be activated. These functions are available by default only at the “Expert” user level.

If you wish to open the folds, activate the option “Program” -> “FOLD” -> “All FOLDS opn”. Then select the command “Configure” -> “Miscellaneous” -> “Detail view on/off”.

Program

- Q FOLD ▶
 - Q Current FOLD opn/cls
 - 1 All FOLDS opn
 - 2 All FOLDS cls
- 1 Copy
- 2 Paste
- 3 Cut
- 4 Delete
- 5 Find...
- 6 Replace
- Z Close

Configure

- Q I/O ▶
- 1 I/O Driver ▶
- 2 SUBMIT Interpreter ▶
- 3 Statuskeys ▶
- 4 Jogging ▶
- 5 User group
- 6 Cur. tool/base
- 7 Tool definition ▶
- 8 On/Off options ▶
- 9 Miscellaneous ▶
 - Q Language
 - 1 Change password
 - 2 Editor ▶
 - 3 Office GUI on/off
 - 4 Monitoring working envelope ▶
 - 5 Technology selection
 - 6 Reinit ▶
- Q Def-line
- 1 Detail view on/off
- 2 Linebreak ON/OFF

File	Program	Configure	Monitor	Setup	Commands	Technology	Help																																
<pre> 1 INI 2 BAS INI 3 INTERRUPT DECL 3 WHEN ↳ \$STOPMESS=555=TRUE DO ↳ IR_STOPM () 4 INTERRUPT ON 3 5 BAS (L#INITMOV,0) 6 A20 INI 7 IF ARC20==TRUE TRUE THEN 8 A20 (ARC_INI) 9 INTERRUPT DECL 600000 WHEN ↳ \$CYCFLAGG[3]==FALSE DO ↳ A20(TECH_STOP2) 10 ENDIF 11 A10 INI 12 IF A10 OPTION==#ACTIVE THEN 13 INTERRUPT DECL 4 WHEN ↳ \$CYCFLAG[2]==FALSE DO A10 ↳ (#APPL_ERROR) </pre>				<table border="1" style="width: 100%; border-collapse: collapse;"> <thead> <tr> <th>Line</th> <th>Col</th> <th>Error...</th> <th>Description</th> </tr> </thead> <tbody> <tr> <td>4</td> <td>35</td> <td>2161</td> <td>'DO' expected</td> </tr> <tr> <td>6</td> <td>6</td> <td>2139</td> <td>Specified typ...</td> </tr> <tr> <td>9</td> <td>9</td> <td>2241</td> <td>Right operan...</td> </tr> <tr> <td>11</td> <td>19</td> <td>2347</td> <td>Value for PR...</td> </tr> <tr> <td>17</td> <td>50</td> <td>2138</td> <td>Name invalid...</td> </tr> <tr> <td>18</td> <td>14</td> <td>2319</td> <td>'ON','OFF','E...</td> </tr> <tr> <td>32</td> <td>38</td> <td>2135</td> <td>Name not de...</td> </tr> </tbody> </table>		Line	Col	Error...	Description	4	35	2161	'DO' expected	6	6	2139	Specified typ...	9	9	2241	Right operan...	11	19	2347	Value for PR...	17	50	2138	Name invalid...	18	14	2319	'ON','OFF','E...	32	38	2135	Name not de...		
Line	Col	Error...	Description																																				
4	35	2161	'DO' expected																																				
6	6	2139	Specified typ...																																				
9	9	2241	Right operan...																																				
11	19	2347	Value for PR...																																				
17	50	2138	Name invalid...																																				
18	14	2319	'ON','OFF','E...																																				
32	38	2135	Name not de...																																				
<p>KRC:R1\PROG_04.SRC Ln 1, Col 3</p> <table border="1" style="width: 100%; border-collapse: collapse;"> <thead> <tr> <th>Ti...</th> <th>no.</th> <th>Source</th> <th>Message</th> </tr> </thead> <tbody> <tr> <td>!</td> <td>15:09 1008</td> <td>Controller</td> <td>booted</td> </tr> <tr> <td>!</td> <td>15:10 1326</td> <td>HPU</td> <td>/R1/PROG_04 : 7 compilation error</td> </tr> <tr> <td>!</td> <td>15:12 38</td> <td>BDF</td> <td>PowerOn finished.</td> </tr> <tr> <td>!</td> <td>15:21 8</td> <td>UserMode</td> <td>User group: Expert</td> </tr> </tbody> </table>				Ti...	no.	Source	Message	!	15:09 1008	Controller	booted	!	15:10 1326	HPU	/R1/PROG_04 : 7 compilation error	!	15:12 38	BDF	PowerOn finished.	!	15:21 8	UserMode	User group: Expert																
Ti...	no.	Source	Message																																				
!	15:09 1008	Controller	booted																																				
!	15:10 1326	HPU	/R1/PROG_04 : 7 compilation error																																				
!	15:12 38	BDF	PowerOn finished.																																				
!	15:21 8	UserMode	User group: Expert																																				
<p>NUM CAPS S I R T1 POV=100% Rob_1 15:25</p> <p>Change Motion Logic Last Cmd. Close NAVIGATOR</p>																																							

The line/column numbers in the error list now correspond to those in the editor, which makes fault location significantly easier.



If the fault is located within a closed fold, the edit cursor will be positioned on the closed fold.

When the file is closed, a request for confirmation is generated asking if the file should really be saved to the hard disk.

Ti...	no.	Source	Message
13:16:38	BOF		PowerOn finished.
13:17:8	UserMode		User group: Expert
13:19:1326	HPU		/R1/PROG_04: 7 compilation error
14:03:34	BOF		KRC:\R1\prog_04.SRC modified. Save changes?

NUM	CAPS	S	I	R	T1	POV=100%	R_Name	13:03
Cancel						Yes	No	

Once the file has been successfully saved, you can verify in the message window whether the error has been successfully corrected.

Ti...	no.	Source	Message
13:16:38	BOF		PowerOn finished.
13:17:8	UserMode		User group: Expert
13:19:1326	HPU		/R1/PROG_04: 7 compilation error
14:11:1326	HPU		/R1/PROG_04: 6 compilation error

Refresh

The error display window is updated, showing the number of errors that have occurred and the source text.

Line	Col.	Error ...	Description
4	35	2161	'D0' expected
6	6	2139	Specified typ...
9	9	2241	Right operan...
11	19	2347	Value for PR...
17	50	2138	Name invalid...
18	14	2319	'ON','OFF','E...
32	38	2135	Name not de...

```

***INTERRUPT DECL 3 WHEN
$STOPMESS=555=TRUE DO IR_STOPM ()
'D0' expected
  
```

Close

The error list is closed.

5.2.6.2 Edit

This command opens the file selected in the file list. This can be either a "SRC" file or a "DAT" file.

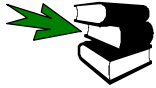

Further information about the "Edit" command can be found in Section 5.3.2.

5.2.6.3 Data list

The "DAT" file belonging to the program is loaded for editing. The data list can then be modified.

File	Program	Configure	Monitor	Setup	Commands	Technology	Help																
1	EXTERNAL DECLARATIONS						100%																
2							100%																
3	DECL BASIS_SUGG_T LAST_BASIS={POINT1[] "P5 ",POINT2[] "P5 ",CP_PARAMS[] "CPDAT3 ",PTP_PARAMS[] "PDAT2 ",CONT[] " ",CP_VEL[] " 2 ",																						
4	PTP_VEL[] "100 "} DECL E6POS XP1={x 1620.001,y 0.0,z 1910.0,a 0.0,b 90.0,c 0.0,s 2,t 2,e1 0.0,e2 0.0,e3 0.0,e4 0.0,e5 0.0,e6 0.0}																						
5	DECL FDAT FP1={TOOL_NO 1,BASE_NO 0,IPO_FRAME #BASE}																						
6	DECL PDAT PPDAT1={VEL 100.0,ACC 100.0,APO_DIST 100.0}																						
7	DECL E6POS XP2={x 1620.001,y 0.0,z 1910.0,a 0.0,b 90.0,c 0.0,s 2,t 2,e1 0.0,e2 0.0,e3 0.0,e4 0.0,e5 0.0,e6 0.0}																						
8	DECL FDAT FP2={TOOL_NO 1,BASE_NO 1,IPO_FRAME #BASE}																						
9	DECL LDAT LCPDAT1={VEL 2.0,ACC 100.0,APO_DIST 100.0,APO_FAC 50.0}																						
10	DECL E6POS XP3={x 1620.001,y 0.0,z 1910.0,a 0.0,b 90.0,c 0.0,s 2,t 2,e1 0.0,e2 0.0,e3 0.0,e4 0.0,e5 0.0,e6 0.0}						7																
11	DECL FDAT FP3={TOOL_NO 1,BASE_NO 1,IPO_FRAME #BASE}																						
KRC-VR1\PROG_04.DAT							Ln 1, Col 0																
<table border="1"> <thead> <tr> <th>Ti...</th> <th>no.</th> <th>Source</th> <th>Message</th> </tr> </thead> <tbody> <tr> <td>!</td> <td>15:09 1008</td> <td></td> <td>Controller booted</td> </tr> <tr> <td>!</td> <td>15:10 1326</td> <td>HPU</td> <td>/R1/PROG_04: 7 compilation error</td> </tr> <tr> <td>!</td> <td>15:12 38</td> <td>BOF</td> <td>PowerOn finished.</td> </tr> </tbody> </table>							Ti...	no.	Source	Message	!	15:09 1008		Controller booted	!	15:10 1326	HPU	/R1/PROG_04: 7 compilation error	!	15:12 38	BOF	PowerOn finished.	7
Ti...	no.	Source	Message																				
!	15:09 1008		Controller booted																				
!	15:10 1326	HPU	/R1/PROG_04: 7 compilation error																				
!	15:12 38	BOF	PowerOn finished.																				
NUM CAPS S I R				T1	POV=100%	Rob_1	15:30																
						Close	NAVIGATOR																

5.2.6.4 Delete



The description of this command can be found in Section 5.4.5.



5.3 “File” menu

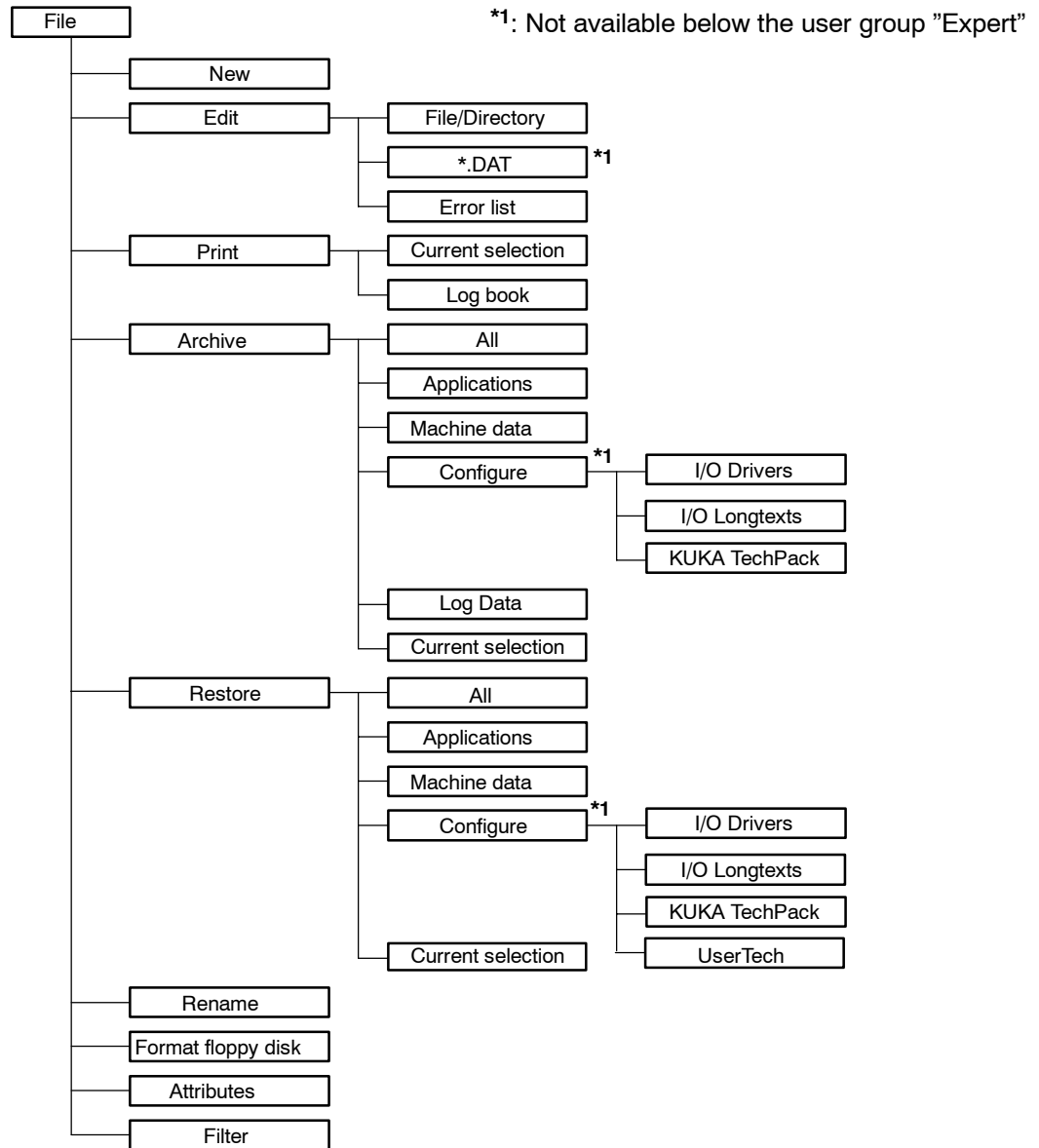

File

Open the menu "File" by pressing the corresponding menu key. The following menu is then displayed:

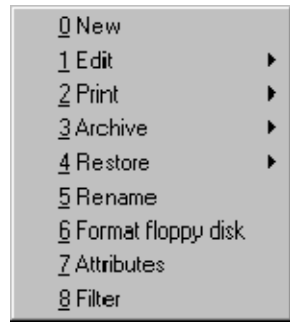

*1 The menu command "Filter" is only offered at expert level.

*1

The following menu commands are available for be selection:

5.3.1 New



To be able to create a folder or module at all, the program window must first be active, i.e. highlighted in color. If it is not, press the "Window selection" key until the program window is activated.

The folder or module name can be entered in the input line. This name can have a maximum of 24 characters. In the case of programs, a comment may optionally be entered.



The symbol next to the input line indicates whether a folder or a file is being created.



Numbers for folder and program names are entered using the numeric keypad on the KCP. To do this, the "NUM" display in the status line must be deactivated. If this is not the case, please toggle this function.



The menu command "New" is also available in the softkey bar.



If a program has already been selected or there is a program in the editor, you must first toggle to the Navigator. No new program can be created until this is done.

5.3.1.1 Create folder

To do this, the focus must be located in the directory structure.

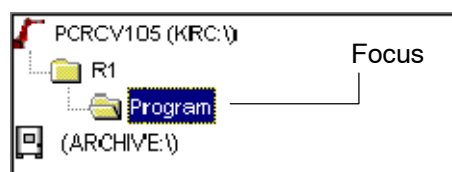

File

Then select the command "New" under the menu "File", or press the corresponding softkey. Enter the desired name of the folder in the input line.

Name	Comment	Changed	#
main	HAUPTPROGRA...	12.04.00 14:50:22	1
sub_1		12.04.00 14:50:22	1
sub_2		12.04.00 14:50:22	1
sub_3		12.04.00 14:50:22	1
teil_a	BAUTEIL 1	12.04.00 14:50:24	1
teil_b	BAUTEIL 2	12.04.00 14:50:24	1
Prog_		----	----

OK

To create the folder, press the softkey “OK” or the Enter key.



The desired file is automatically saved on the hard disk and displayed shortly afterwards in the file window.

5.3.1.2 Create module

To do this, the focus must be located in the file list.

Name	Comment	Changed	#
Program		16.02.00 14:35:52	
cell	HANDLER ON E...	07.02.00 10:33:12	
prog_01	TESTPROGRAMM	07.02.00 10:33:12	3

Focus

File

Then select the command “New” under the menu “File”, or press the corresponding softkey. Enter the desired name of the module in the input line.

Name	Comment	Changed	#
Program		16.02.00 14:35:52	
cell	HANDLER ON E...	07.02.00 10:33:12	
prog_01	TESTPROGRAMM	07.02.00 10:33:12	3
prog_02	START_APPL-1	07.02.00 14:51:34	2
prog_03	START_APPL-2	07.02.00 14:43:22	1
prog_04		09.02.00 14:41:18	15
test	TEST	07.02.00 14:41:52	1
Prog_		----	----



A comment can be entered along with the program name for the purpose of easier identification. The relevant input box in the form is accessed using the “→” arrow key. The first 15 characters of the comment, at most, are displayed in the file list.

Prog_10	Comment	----	----
---------	---------	------	------



The comment can also be altered later in the attributes display. More detailed information about this can be found in Section 5.2.3.2.



To accept the program “Prog_10” with the note “Comment”, press the softkey “OK” or the Enter key.



The desired file is automatically saved on the hard disk and displayed shortly afterwards in the file window.

By following this procedure, a so-called “skeleton program” will be created, the program name being shown in the file list.

If a module with this name already exists, a corresponding message is generated in the message window.

Time	no.	Source	Message
13:50	1008		Controller booted
13:52	38	BOF	PowerOn finished.
14:00	75	C3FIL	File already exist.
14:00	17	Navigator	Replace file?

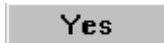

The softkey “Yes” overwrites the existing file

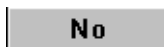

“No” or “Cancel” rejects the current program creation and closes the input line



At expert level, in addition to modules other program files can be created. For this purpose, when the command “New” is selected, instead of an input line a window is opened offering a selection of the various templates available. Further information about filters and templates can be found in Section 5.2.3.3.

Filename	Filter comment
Cell	Automatik extern dispatcher
Expert	Expert module
Expert Submit	Expert submit
Function	Function
Modul	Module
Submit	User submit



Where possible, create user programs in the directory “R1\Program” in order to ensure that they are automatically saved via the menu item “File” -> “Archive” -> “Applications”.

5.3.2 Edit

The selected program or Folge is loaded for editing in the editor.

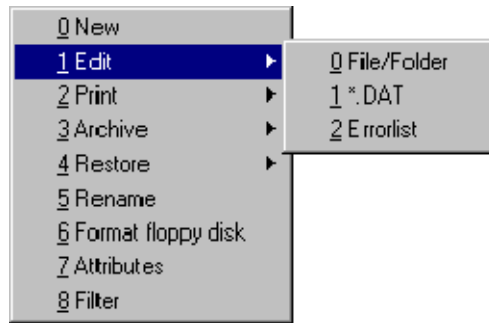

Once the submenu “Edit” has been selected, the following options are available:

5.3.2.1 Open a subdirectory

To do this, the focus must be located in the folder list.



5.3.2.2 Load file into the editor

While a program is being edited, the robot can at the same time be executing another program in the background.

```

1  INI
2  PTP HOME  Ve1= 100 % DEFAULT
3
4  PTP P1  Ve1= 100 % PDAT1 Tool:1 Base:0
5  PTP P2  Ve1= 100 % PDAT2 Tool:1 Base:0
6  PTP P4  Ve1= 100 % PDAT4 Tool:1 Base:0
7  PTP P8  Ve1= 100 % PDAT6 Tool:1 Base:0
8  PTP P5  Ve1= 100 % PDAT5 Tool:1 Base:0
9
10 PTP HOME  Ve1= 100 % DEFAULT
    
```

Example of an “SRC” file

The desired program is displayed in the program window. The assignment of the menu key, softkey and status key bars changes at the same time, in order to make functions available which are necessary for programming the robot.

If you have opened a program which has so far only been initially created, the so-called “skeleton program” is displayed in the programming window as the necessary basis for every program. The following screenshot shows such a skeleton program.

```

1  INI
2  PTP HOME  Ve1= 100 % DEFAULT
3
4
5  PTP HOME  Ve1= 100 % DEFAULT
    
```

5.3.2.3 Edit a data list

```

1  [EXTERNAL DECLARATIONS
2
3  DECL BASIS_SUGG_T LAST_BASIS={POINT1[] "P8
  ↳  ",POINT2[] "P8 " ,CP_PARAMS[] "CPDAT0
  ↳  ",PTP_PARAMS[] "PDAT6 " ,
  ↳  CONT[] " " ,CP_UEL[] "2
  ↳  ",PTP_UEL[] "100 " }
4  DECL E6POS XP1={x 1620.001,y 0.0,z 1910.0,a 0.0,b 90.0,c 0.0,
  ↳  s 2,t 2,e1 0.0,e2 0.0,e3 0.0,e4 0.0,e5 0.0,e6 0.0}
5  DECL FDAT FP1={TOOL_NO 1,BASE_NO 0,IPO_FRAME #BASE}
6  DECL PDAT PPDAT1={VEL 100.0,ACC 100.0,APO_DIST 100.0}
7  DECL E6POS XP2={x 1620.001,y 0.0,z 1910.0,a 0.0,b 90.0,c 0.0,
  ↳  s 2,t 2,e1 0.0,e2 0.0,e3 0.0,e4 0.0,e5 0.0,e6 0.0}
8  DECL FDAT FP2={TOOL_NO 1,BASE_NO 0,IPO_FRAME #BASE}
9  DECL PDAT PPDAT2={VEL 100.0,ACC 100.0,APO_DIST 100.0}
10 DECL E6POS XP3={x 1620.001,y 0.0,z 1910.0,a 0.0,b 90.0,c 0.0,
  ↳  s 2,t 2,e1 0.0,e2 0.0,e3 0.0,e4 0.0,e5 0.0,e6 0.0}
11 DECL FDAT FP3={TOOL_NO 1,BASE_NO 0,IPO_FRAME #BASE}
12 DECL PDAT PPDAT3={VEL 100.0,ACC 100.0,APO_DIST 100.0}

```

Example of a "DAT" file

5.3.2.4 Open an error list

Line	Col.	Error ...	Description
4	35	2161	'D' expected
6	6	2139	Specified typ...
9	9	2241	Right operan...
11	19	2347	Value for PR...
17	50	2138	Name invalid...
18	14	2319	'ON','OFF','E...
32	38	2135	Name not de...

INTERRUPT DECL 7 WHEN
 A_ARC_SWI==#ACTIVE DO A10
 (#ARC_ON_SEAM)
 Name invalid for this type of constant.

Example of an error list



A detailed description of the error list can be found in Section 5.2.6.1.

Further information about programs can be found in the documentation **[User Programming]**, chapters **[Program editing]**, **[Program commands]**.

5.3.3 Print

You can use this command to create printouts of the current selection and the logbook. This can take some time, depending on the amount of data to be printed.

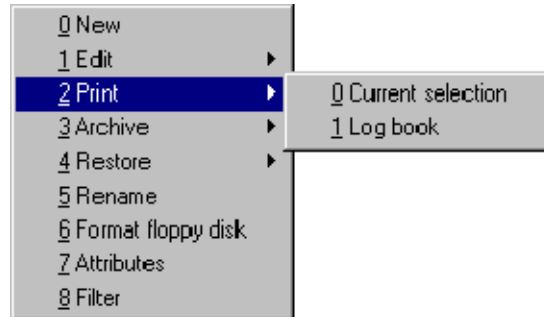

5.3.3.1 Current selection

The selected files are sent to the printer.

Filter: User		Contents of: R1			
Name	Comment	Changed	#		
Program		16.02.00 14:35:52			
cell	HANDLER ONE...	07.02.00 10:33:12			
prog_01	TESTPROGRAMM	07.02.00 10:33:12	3		
prog_02	START_APPL-1	07.02.00 14:51:34	2		
prog_03	START_APPL-2	07.02.00 14:43:22	1		
prog_04		09.02.00 14:41:18	15		
test	TEST	07.02.00 14:41:52	1		



File name KRC:\R1\PROG_02.SRC

```

INI
BAS INI
A20 INI
A10 INI
GRIPPER INI
SPOT INI
TOUCHSENSE INI
USER INI
PTP HOME Vel= 100 % DEFAULT
$BWDSTART = TRUE
$H_POS=XHOME
PDAT_ACT=PDEFAULT
BAS (#PTP_DAT )
FDAT_ACT=FHOME
BAS (#FRAMES )
BAS (#VEL_PTP,100 )
PTP XHOME

PTP P1 Vel= 100 % PDAT1 TOOL:1 BASE:0
$BWDSTART = FALSE
PDAT_ACT=PPDAT1
BAS (#PTP_DAT)
.
.
.

```



```
File name KRC:\R1\PROG_02.DAT
EXTERNAL DECLARATIONS
BAS EXT
EXT BAS (BAS_COMMAND :IN,REAL :IN )
DECL INT SUCCESS
A10 EXT
A20 EXT
GRIPPER EXT
.
.
.
```

5.3.3.2 Log book

This command sends the logbook, which can be viewed via the menu “Monitor” -> “Diagnosis” -> “Log book”, to the printer.



```
.
.
.
#9
-----
08:21:15'254 11.02.2000 No.:5001: File modified /R1/$CONFIG.DAT
SOURCE: System

#10
-----
08:21:15'081 11.02.2000 No.:306: Selection active
Source: System

#11
-----
08:21:14'956 11.02.2000 No.:0: Program KRC:\R1\Prog_02 selected
.
.
.
```

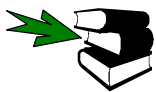

Detailed information on the logbook can be found in the **Operating Handbook**, chapter **[Monitor Functions]**, section **[Diagnosis]**, under **“Log book”**.

5.3.4 Archive

This function allows you to save important data to floppy disk.

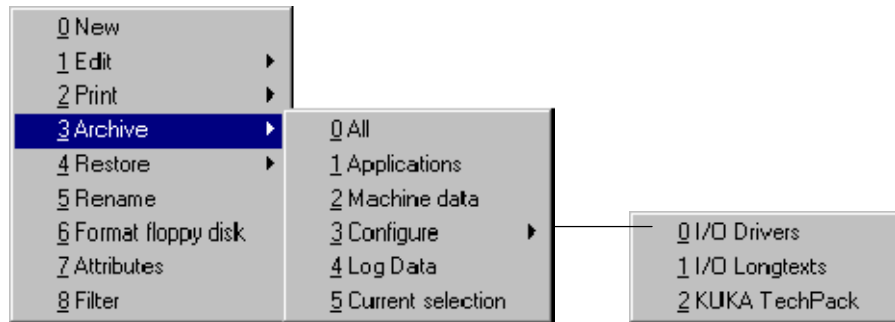

A request for confirmation is generated which must be answered before the saving process is carried out.

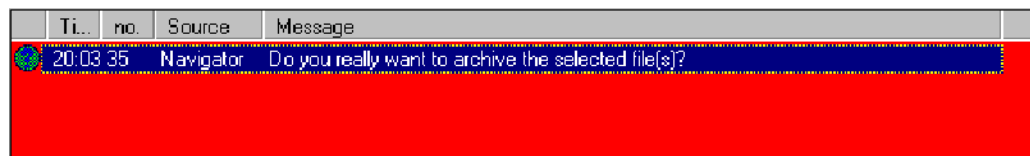

- Yes** The selected files are archived
- No** The selected files are not archived



If you try to insert an existing file in an archive, the robot name is checked. The robot name in the archive is compared with the name that is set in the controller. If the two names are different, a request for confirmation is generated asking if you really wish to overwrite the existing archive.

The progress of the operation is displayed in the message window:



Completion of the operation is also indicated:

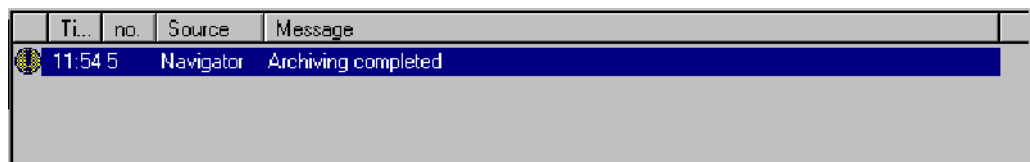

5.3.4.1 All

The following files are saved to floppy disk:

All
"KRC:" "C:\KRC\Data\ "C:\KRC\Roboter\Init\ "C:\KRC\Roboter\Ir_Spec\ "C:\KRC\Roboter\Log\ "C:\KRC\Roboter\Template\



The menu command "File" -> "Archive" -> "All" is also offered in the softkey bar.



5.3.4.2 Applications

All programs in the listed folders are saved:

Applications
"KRC:\R1\Program\ "KRC:\R1\System\ "KRC:\Steu\\$Config.dat"

5.3.4.3 Machine data

The following files and folders can be selected:

Machine data
"KRC:\R1\MaDa\ "KRC:\Steu\MaDa\ "KRC:\Steu\\$Config.dat" "C:\KRC\Roboter\lr_Spec"

5.3.4.4 Configure

The configurations of the following technologies are available:

I/O Drivers
"C:\KRC\Roboter\Init"
I/O Longtexts
"C:\KRC\Roboter\Init"
KUKA TechPack
The corresponding registry entries are saved here.

5.3.4.5 Log Data

The log book data, which can be viewed using the diagnostic logbook function, are written to the hard disk.

Log Data
"C:\KRC\Roboter\Log"

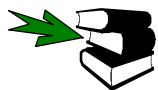

Detailed information on the logbook function can be found in the chapter **[Monitor Functions]**, in the section **[Diagnosis]**.

For information on printing the logbook data, see Section 5.3.3.

5.3.4.6 Current selection

The selected files are saved on the floppy disk in drive A:\.

Filter: User		Contents of: R1			
Name	Comment	Changed	#		
prog_01	TESTPROGRAMM	07.02.00 01:00:00	3		
prog_02	START_APPL-1	07.02.00 01:00:00	2		
prog_03	START_APPL-2	07.02.00 01:00:00	1		
prog_04		09.02.00 01:00:00	15		
sps	PLC ON CONTR...	04.02.00 01:00:00			
sub_1		10.02.00 01:00:00	1		



The menu command "File" -> "Archive" -> "Current selection" is also available in the softkey bar.

New	Select	Duplicate	Archive	Delete	Open
-----	--------	-----------	---------	--------	------

5.3.5 Restore

This command enables previously saved ZIP files to be written from floppy back on to the hard disk.

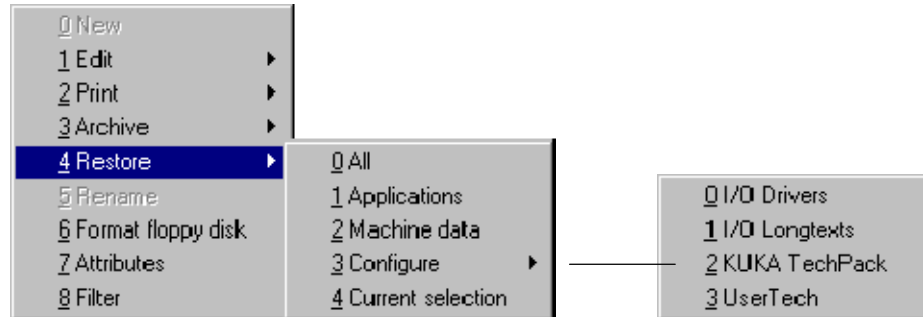

This function is particularly useful, for example, if programs on the hard disk have become damaged or if you wish to return a program to its original state after substantial changes have been made to it. The files on the hard disk are hereby overwritten.

A request for confirmation is thus generated which must be answered before the saving process is carried out.



The action will then be displayed in the message window:

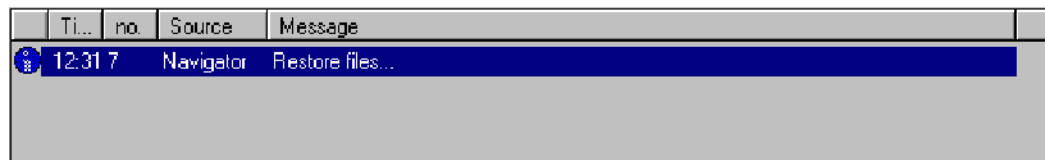

After a short wait time the end of the operation is shown:

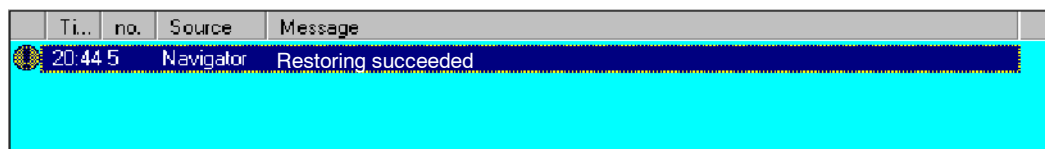

5.3.5.1 All

All data, with the exception of log files, are loaded from the floppy disk back onto the hard disk. The I/O drivers are also reconfigured. The user interface is then reinitialized in order to update any changes, e.g. to the menu structure (MenueKeyUser.ini).

Acknowledge the motion enable following restoration.

Ti...	no.	Source	Message
!	20:44 16	BOF	'KUKATPUSER' reinitialized
!	20:44 16	BOF	'KUKATPEXPERT' reinitialized
!	20:44 31	Navigator	Restoring succeeded
100	20:44 1210	KS	Ackn. general motion enable

All
"KRC:\" "C:\KRC\Data\ "C:\KRC\Roboter\Init\ "C:\KRC\Roboter\IR_Spec\ "C:\KRC\Roboter\Template\



The menu command "File" -> "Restore" -> "Restr. All" in the softkey bar has the same function.

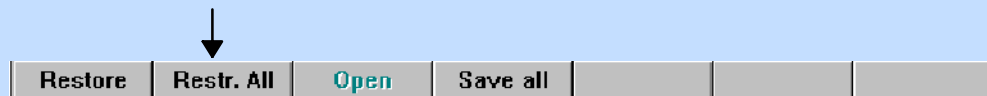

Following reinitialization, the user interface must be reloaded using the command "Configure" -> "Miscellaneous" -> "BOF Reinitialization" in order to ensure that changes to the menu structure (MenuKeyUser.ini) are displayed correctly.

5.3.5.2 Applications

The following directories and files are written back on to the hard disk:

Applications
"KRC:\R1\Program\ "KRC:\R1\System\ "KRC:\Steu\\$Config.dat"

5.3.5.3 Machine data

Only machine data are loaded from the floppy disk.

Machine data
"KRC:\R1\MaDa\ "KRC:\Steu\MaDa\ "KRC:\Steu\\$Config.dat" "C:\KRC\Roboter\lr_Spec\



To restore individual files from the floppy disk, move the focus to the "Archive:\\" symbol and open the directory "Disk" (corresponds to drive A:). Then switch to the data list, locate the desired files and paste them using the edit functions ("Program" menu). See also Section 5.4.

Filter: Modules		Contents of Disk			
Name	#	Changed	Comment		
PCRCV105 (KRC:\)					
(ARCHIVE:\)					
Disk					
\$config	4	20.01.99 16:27:39			
\$config		20.01.99 16:27:39			
\$custom		20.01.99 16:27:39			
\$machine	3	20.01.99 16:27:39			
\$machine		20.01.99 16:27:39			
\$option		20.01.99 16:27:39			
\$robot		20.01.99 16:27:39			

5.3.5.4 Configure

Only the selected data are loaded back onto the hard disk:

I/O Drivers
"C:\KRC\Roboter\Init"
I/O Longtexts
"C:\KRC\Data\Kuka_Con.mdb"
KUKA TechPack
The corresponding registry entries are restored here.
UserTech
"C:\KRC\Roboter\Init\MenueKeyUser.ini"
"C:\KRC\Roboter\Init\SoftKeyUser.ini"
"C:\KRC\Roboter\Template\"



Once the long text database (Kuka_Con.mdb) has been written back onto the hard drive, the restored version is immediately available.

5.3.5.5 Current selection

Only the selected files or directories in the drive "Archive:\Disk" are written back to the hard disk.

Filter: User		Contents of: R1			
Name	Comment	Changed	#		
PCRCV105 (KRC:\)					
R1					
Program					
(ARCHIVE:\)					
Disk					
prog_01	TESTPROGRAMM	07.02.00 01:00:00	3		
prog_02	START_APPL-1	07.02.00 01:00:00	2		
prog_03	START_APPL-2	07.02.00 01:00:00	1		
prog_04		09.02.00 01:00:00	15		
sps	PLC ON CONTR...	04.02.00 01:00:00			
sub_1		10.02.00 01:00:00	1		



The menu command "File" -> "Restore" -> "Current selection" has the same function as the corresponding softkey.

Restore	Restr. All	Open	Save all		
---------	------------	------	----------	--	--

The floppy disk drive A:\ can be accessed directly at expert level:

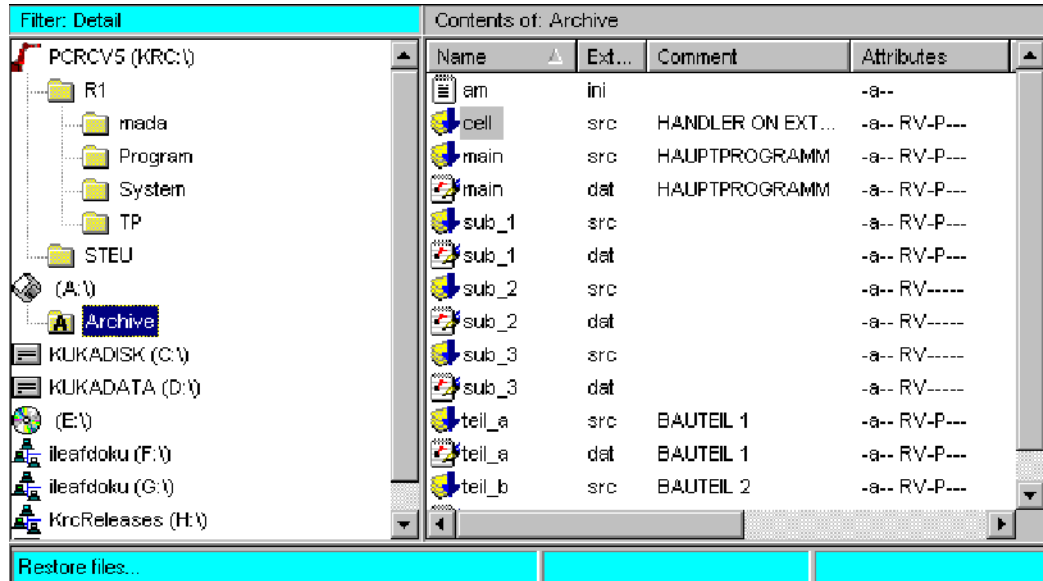

Name	Ext...	Comment	Attributes
am	ini		-a--
cell	src	HANDLER ON EXT...	-a-- RV-P---
main	src	HAUPTPROGRAMM	-a-- RV-P---
main	dat	HAUPTPROGRAMM	-a-- RV-P---
sub_1	src		-a-- RV-P---
sub_1	dat		-a-- RV-P---
sub_2	src		-a-- RV-----
sub_2	dat		-a-- RV-----
sub_3	src		-a-- RV-----
sub_3	dat		-a-- RV-----
teil_a	src	BAUTEIL 1	-a-- RV-P---
teil_a	dat	BAUTEIL 1	-a-- RV-P---
teil_b	src	BAUTEIL 2	-a-- RV-P---

5.3.6 Rename

The command “Rename” allows you to change the name or the comment line of a program.

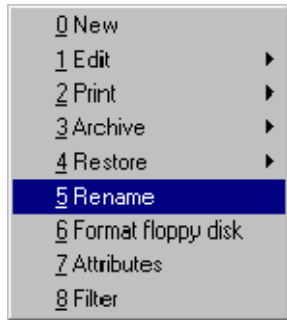

In the right-hand Navigator window, select the file or folder that you would like to rename. Then activate the command “File” -> “Rename” and carry out the desired changes.

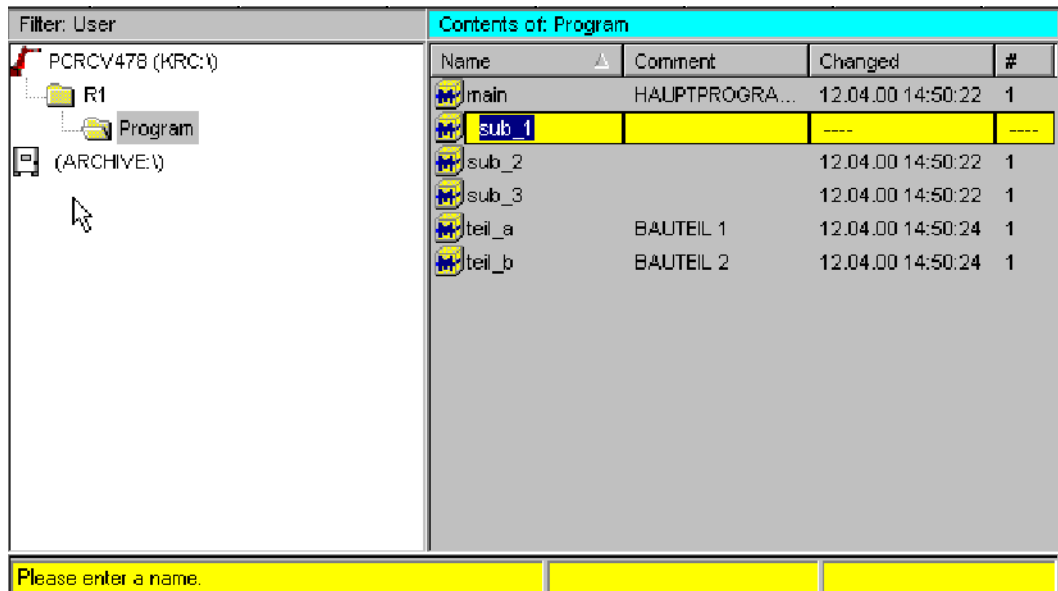

You can move to the next input box in the form using the “→” arrow key.



Then confirm the action using the softkey “OK” or the Enter key, or cancel the action by pressing the softkey “Cancel” or the Escape key.



At expert level the file extension (“SRC”, “DAT” or “SUB”) is shown.





The renamed file is automatically saved on the hard disk. If a name is entered which already exists, a corresponding error message is displayed in the message window and the action is cancelled.



Certain folders cannot be renamed, depending on the particular configuration. In this case, the menu command and the corresponding softkey cannot be selected.

5.3.7 Format floppy disk

The contents of a 1.44 MB floppy disk in drive A:\ are deleted using Quickformat.

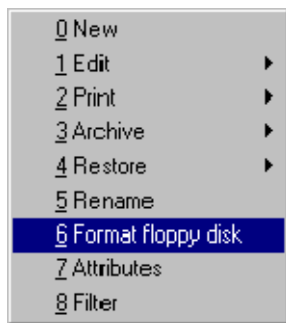

After the menu item “File” → “Format floppy disk” is selected, a request for confirmation is generated in the message window, which must be answered.

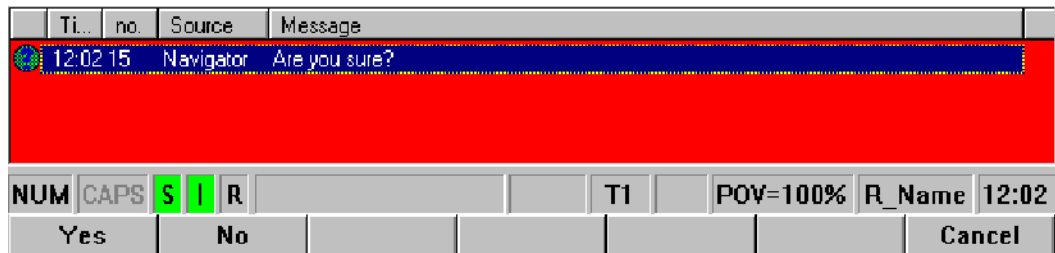

If the formatting has been completed, a corresponding output is generated in the message window.

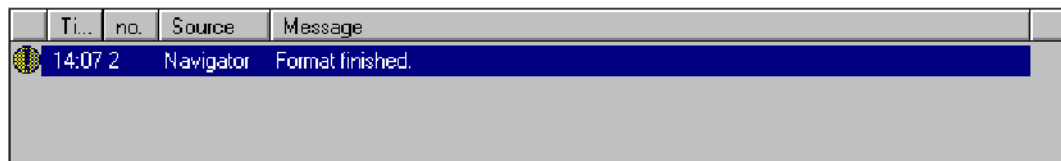

The floppy disk must not be removed from the disk drive until this message has appeared in the message window and the LED on the disk drive is no longer lit. Otherwise the disk drive and/or the floppy disk could suffer irreparable damage.

5.3.8 Attributes

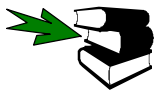
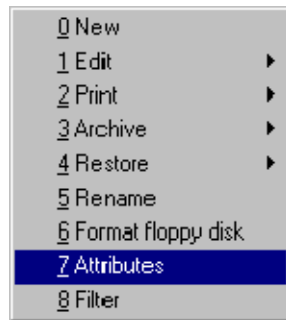

Further information about the attributes display can be found in Section 5.2.3.2.

5.3.9 Filter

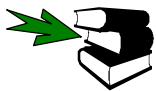
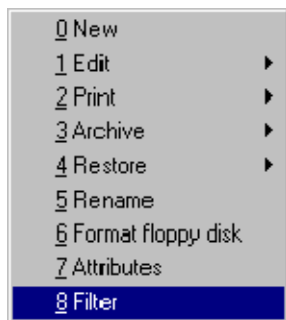

More detailed information about the “Filter” can be found in Section 5.2.3.3.

5.4 “Edit” menu

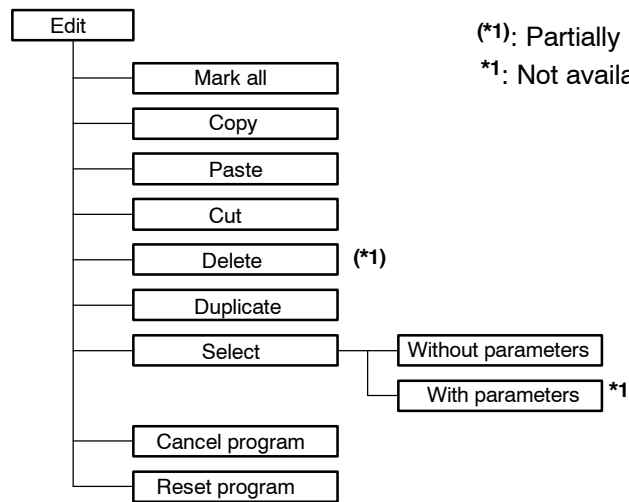

Edit

To open the “Program” menu, press the corresponding menu key. The following menu is then displayed:



5.4.1 Mark all

All directories and files in the file list are selected for editing.

Contents of: Program					
Name	Ext...	Comment	Attributes	Size	
main	src	HAUPTPROGRA...	-a--RV----	3 K	
main	dat	HAUPTPROGRA...	-a--RV----	2 K	
sub_1	src		-a--RV----	2 K	
sub_1	dat		-a--RV----	2 K	
sub_2	src		-a--RV----	2 K	
sub_2	dat		-a--RV----	2 K	
sub_3	src		-a--RV----	2 K	
sub_3	dat		-a--RV----	2 K	
teil_a	src	BAUTEIL 1	-a--RV----	3 K	
teil_a	dat	BAUTEIL 1	-a--RV----	2 K	
teil_b	src	BAUTEIL 2	-a--RV----	3 K	
teil_b	dat	BAUTEIL 2	-a--RV----	2 K	

The selection of directories or files can only be cancelled if

- another directory is selected in the directory tree,
 - the space-bar is pressed when the focus is located on the desired symbol in the file list,
- or
- the “ESC” key is pressed.

5.4.2 Copy

Selected directories and files are copied to the clipboard. The copied folders and files can then be pasted in a different position.

5.4.3 Paste

After a request for confirmation, folders and files from the clipboard are inserted at the current position (“Copy”), or moved there (“Cut”).

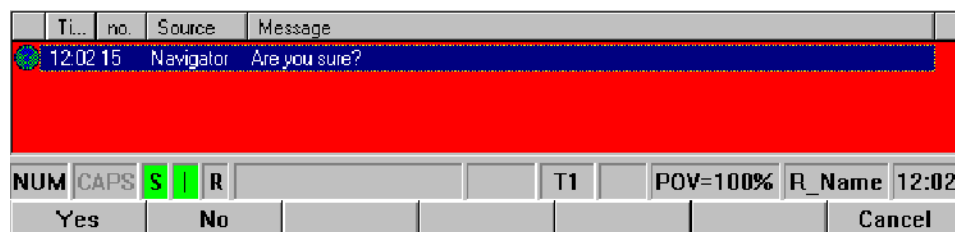

This command is only available if there are data in the clipboard.

5.4.4 Cut

Selected folders are first copied to the clipboard. When this is done, the icons of the selected folders will appear dimmed.

Contents of: Program				
Name	△	Comment	Changed	#
main		HAUPTPROGRA...	10.02.00 12:32:52	1
sub_1			10.02.00 12:30:28	1
sub_2			10.02.00 12:30:38	1
sub_3			10.02.00 12:31:08	1
teil_a		BAUTEIL 1	10.02.00 12:33:54	1
teil_b		BAUTEIL 2	10.02.00 12:34:12	1



The file selection can be canceled using the Escape key.

The copied directories and files can then be pasted in a different position. A request for confirmation is generated here also.

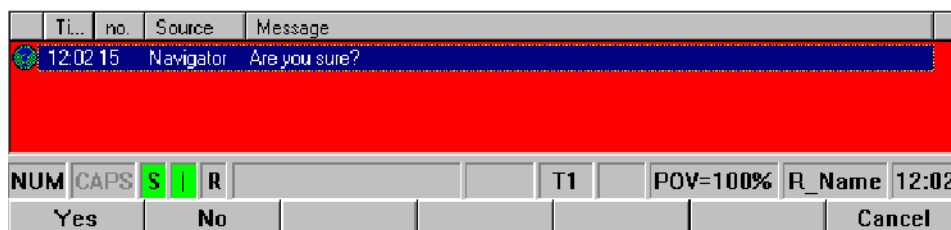

After being inserted, the folders and files are deleted from their original locations.

5.4.5 Delete

The selected files and directories are irrevocably deleted from the hard disk following a request for confirmation. If you want to delete a program, it must not be currently selected or being edited. You might first have to deselect the program or close the editor.

Use the arrow keys to select the program you want to delete, then press the menu command "Program" -> "Delete". A request for confirmation appears in the message window.



Several files can be selected for deletion at the same time. To do this, hold down the "Shift" key while you select the desired files using one of the arrow keys. Files and directories cannot by default be deleted in the user group "User". The corresponding softkeys and menu items cannot be selected.

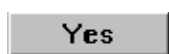
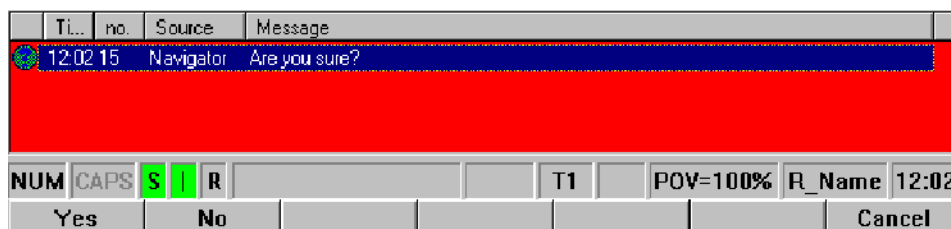

If you press the softkey "Yes", the program is deleted. It is then no longer displayed in the list of programs available.



If you press the softkey "No", the program remains unchanged.

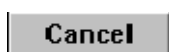

Pressing the softkey "Cancel" immediately terminates the function.



The menu command “Delete” is also available in the softkey bar.



Files and directories cannot by default be deleted in the user group “User”.

5.4.6 Duplicate



Duplicate

The option “Duplicate” creates a copy of a program. In order to be able to create a copy, you must select a file in the program window using the arrow keys “↓” or “↑” and then press the softkey “Duplicate”. A form is then opened in which the name of the selected file is offered as a suggestion.

Name	Comment	Changed	#
main	HAUPTPROGRA...	10.02.00 12:32:52	1
sub_1		10.02.00 12:30:28	1
sub_2		10.02.00 12:30:38	1
sub_3		10.02.00 12:31:08	1
teil_a	BAUTEIL 1	10.02.00 12:33:54	1
teil_b	BAUTEIL 2	10.02.00 12:34:12	1
sub_1		---	---

On the lefthand side of this inline form is the input box “Name”. Here you can enter a name for your program, up to 24 characters long. This name must begin with a letter.

You can additionally enter a text for this program. To do so, press the “→” arrow key to position the edit cursor in the box “Comment” and enter the desired comment.



The entries are saved and the form is closed by pressing the Enter key. The desired program is then created and displayed on the screen.

If you have entered a program name that already exists, an error message is displayed in the message window:

Ti...	no.	Source	Message
14:12 98	C3FIL		A(n) Module with the name "KRC:\R1\Program\Sub_2" already exists!



The menu command “Duplicate” is also available in the softkey bar.

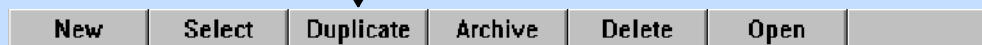

5.4.7 Select

If you want to execute a program, you can use the menu command “File” -> “Select”. Here you can test the program thoroughly.

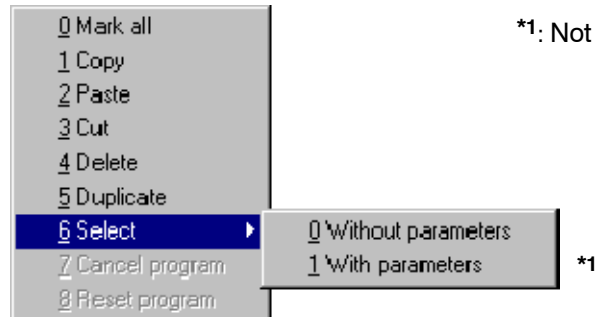

A selected program can continue to run in the background while at the same time another program is being processed in the editor.

5.4.7.1 Without parameters

The desired program is displayed in the program window. The assignment of the menu key, softkey and status key bars changes at the same time, in order to make functions available which are necessary for programming the robot.

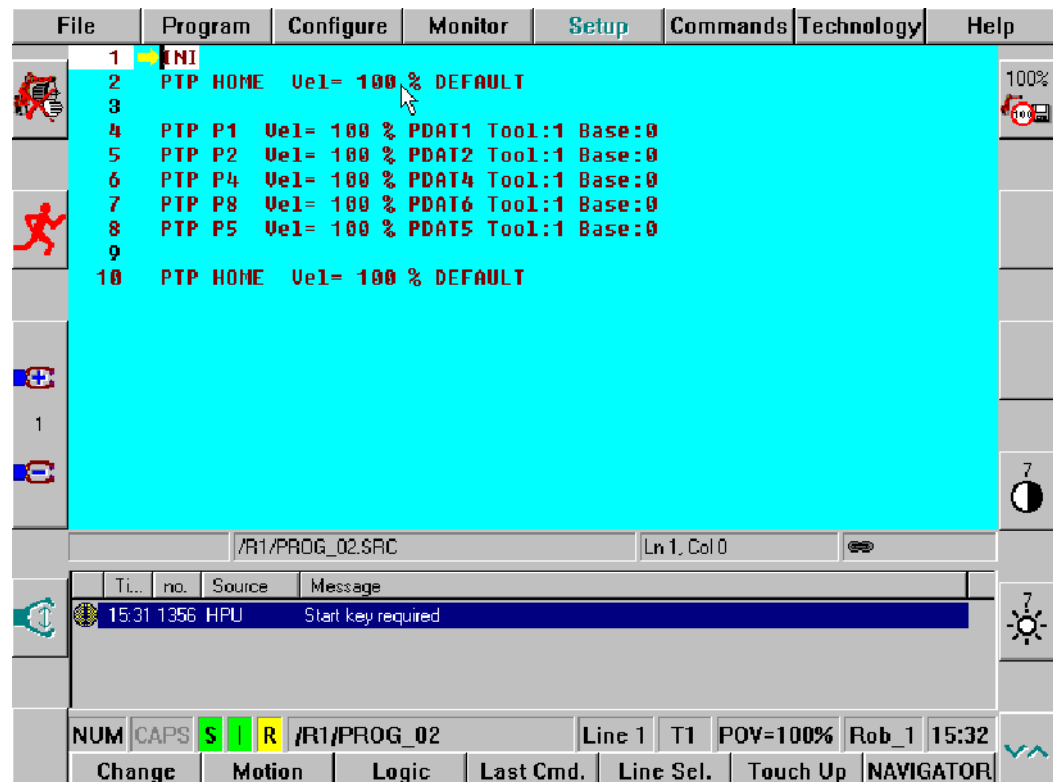

If you have opened a program which has so far only been initially created, the so-called “skeleton program” is displayed in the programming window as the necessary basis for every program. The following screenshot shows such a skeleton program.

```

1  INT
2  PTP HOME  Ve1= 100 % DEFAULT
3
4
5  PTP HOME  Ve1= 100 % DEFAULT

```



The menu command “Select – Without parameters” is also available in the softkey bar.



5.4.7.2 With parameters

At expert level, the entry of parameters is also possible. For this purpose the following form is opened in which the relevant data can be entered:

Please enter parameter:



Additional parameters are necessary if a program requires further entries to be able to run. If, for example, the program “Test.SRC” contains the header

```
DEF TEST(INT :IN, BOOL :OUT)
```

an integer value and a boolean value are transferred when the program is called.

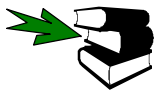

Further information about the program window can be found in the documentation [**User Programming**], in the chapter [**Program editing**].

5.4.8 Cancel program

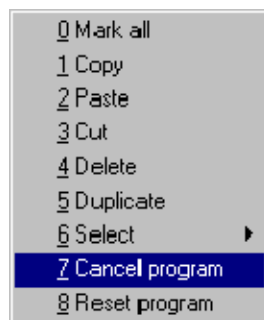

A program that has previously been selected, i.e. one that is ready for execution, can be cancelled via the Navigator. A different program can then be loaded for editing.

5.4.9 Reset program

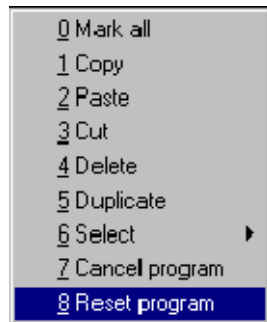

A program selected in the background can be reset via the Navigator. In this way the program can be brought back to the initial state it had immediately after it was loaded.

5.5 “Monitor” menu

Monitor

You can use the submenu “Windows” to toggle between the Navigator, a selected program, and the editor. The function is accessed by pressing the menu key “Monitor” and selecting the submenu “Windows”.

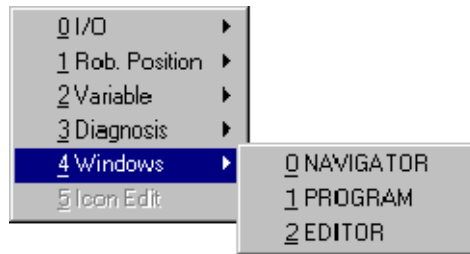

It is then possible to switch between the two windows.



It is also possible to switch between the program, the Navigator and the editor using the corresponding softkey.

NAVIGATOR











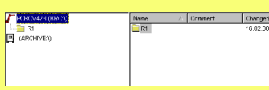

PROGRAM



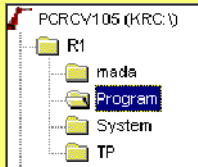
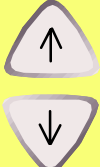

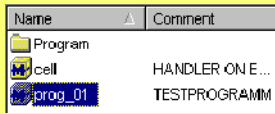

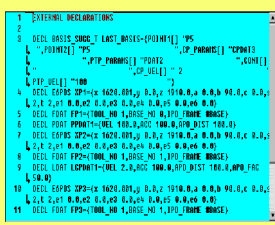
EDITOR

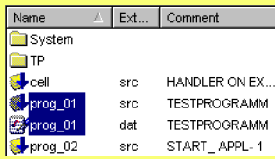
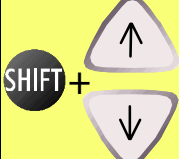
5.6 Appendix

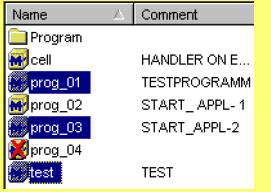
5.6.1 Keyboard assignment of the Navigator

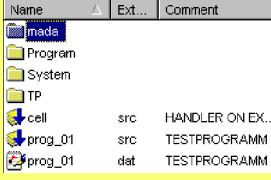
The keys of the KCP for controlling the Navigator are assigned in such a way that selection of files and folders can be carried out using one hand.

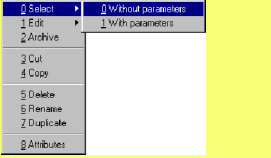
Function		Keys
General		
Change window to/from Folder list and File list		
Toggle numeric keypad to enter either numbers or control characters	 	
Used for entering special characters on the KCP keyboard		
Key for special functions in conjunction with the Windows operating system		
Directory structure		
Select drive / folder		
Open / close drive or folder		
File list		
Select folder / file		
Open folder Select / edit / display module Edit text file		
Select a number of adjacent folders or files		

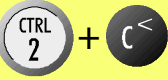
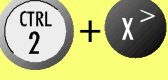
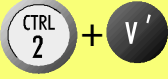
<p>Select individual folders / files Cancel a selection</p>		
<p>Cancel all selections</p>		
<p>Open pop-up menu</p>		
<p>Keyboard shortcuts</p>		
<p>Copy</p>		
<p>Cut</p>		
<p>Paste</p>		



The keys “**SHIFT**” and “**SYM**” remain activated for one keystroke. If more than one special or control character is required, the corresponding key can also be held down. For example, if the “Shift” key is pressed once, the next character will automatically be typed in upper case.

5.6.2 Default settings at User and Expert levels

Visibility of drives and folders	User	Expert
KRC:\	<input checked="" type="checkbox"/>	<input checked="" type="checkbox"/>
R1	<input checked="" type="checkbox"/>	<input checked="" type="checkbox"/>
MaDa	<input type="checkbox"/>	<input checked="" type="checkbox"/>
Program	<input checked="" type="checkbox"/>	<input checked="" type="checkbox"/>
System	<input type="checkbox"/>	<input checked="" type="checkbox"/>
TP	<input type="checkbox"/>	<input checked="" type="checkbox"/>
Steu	<input type="checkbox"/>	<input checked="" type="checkbox"/>
MaDa	<input type="checkbox"/>	<input checked="" type="checkbox"/>
Floppy disk (A:\)	<input checked="" type="checkbox"/>	<input checked="" type="checkbox"/>
Hard disk (C:\)	<input type="checkbox"/>	<input checked="" type="checkbox"/>
CD-ROM drive	<input type="checkbox"/>	<input checked="" type="checkbox"/>
Network drives	<input type="checkbox"/>	<input checked="" type="checkbox"/>
Archive:\	<input checked="" type="checkbox"/>	<input checked="" type="checkbox"/>

User privileges when creating folders	User	Expert
KRC:\	<input type="checkbox"/>	<input checked="" type="checkbox"/>
R1	<input checked="" type="checkbox"/>	<input checked="" type="checkbox"/>
MaDa	<input type="checkbox"/>	<input type="checkbox"/>
Program	<input checked="" type="checkbox"/>	<input checked="" type="checkbox"/>
System	<input type="checkbox"/>	<input checked="" type="checkbox"/>
TP	<input type="checkbox"/>	<input checked="" type="checkbox"/>
Steu	<input type="checkbox"/>	<input type="checkbox"/>
MaDa	<input type="checkbox"/>	<input type="checkbox"/>

Filter	User	Expert
Detail	<input type="checkbox"/>	<input checked="" type="checkbox"/>
Module	<input checked="" type="checkbox"/>	<input checked="" type="checkbox"/>

Templates	User	Expert
Cell	<input type="checkbox"/>	<input checked="" type="checkbox"/>
Module	<input checked="" type="checkbox"/>	<input checked="" type="checkbox"/>
Submit	<input type="checkbox"/>	<input checked="" type="checkbox"/>
Expert Module	<input type="checkbox"/>	<input checked="" type="checkbox"/>
Expert Submit	<input type="checkbox"/>	<input checked="" type="checkbox"/>
Function	<input type="checkbox"/>	<input checked="" type="checkbox"/>

Default directories	Available templates
R1	Cell, Expert, Expert Submit, Function, Module, Submit
MaDa	No
Program	Cell, Expert, Expert Submit, Function, Module, Submit
System	Exp., Exp. Submit, Function, Module, Submit
TP	Exp., Exp. Submit, Function, Module, Submit
Steu	No
MaDa	No



6 Executing, stopping and resetting a program

A precondition for program execution is that the controller is switched on and the graphical user interface (GUI) is active. Information on this can be found in the documentation [Operator Control], in the chapter [Running up / shutting down the controller] and in [The KUKA Control Panel KCP].

6.1 Selecting and opening a program

When the controller is run up, all programs are loaded from the hard disk into the robot's main memory.



In order to make entries when the message window, for example, is active (highlighted in color), the program window must first be activated using the window selection key.

Name	Comment	Changed	#
R1		18.01.00 15:09:52	

Ti..	no.	Source	Message
13:42	1008		Controller booted
13:46	47	BOF	PowerOn finished.



Select

Use the “↓” or “↑” arrow key to select the desired program and then press the softkey “Select” (at the bottom left of the display). The selected program is then displayed in the program window.

```

1 ;EXT EXAMPLE1 ( )
2 ;EXT EXAMPLE2 ( )
3 ;EXT EXAMPLE3 ( )
4
5 *INIT
6 BAS INI
7 CHECK HOME
8 PTP HOME Ue1= 100 % DEFAULT
9 AUTOEXT INI
10 LOOP
11 P00 (#EXT_PGNO,#PGNO_GET,DHV[],0 )
12 SWITCH PGNO ; Select with Programmnumber
13
14 CASE 1
15 P00 (#EXT_PGNO,#PGNO_ACKN,DHV[],0 ) ; Reset
16 Progr.No.-Request
17 ;EXAMPLE1 ( ) ; Call User-Program
18 CASE 2
  
```

Ti..	no.	Source	Message
14:05	1008		Controller booted
14:08	47	BOF	PowerOn finished.
14:13	1356	HPU	Start key required

6.1.1 Symbols in the program window

Various symbols are used in the program window. Their meanings will be explained in this section.

Block pointer (program pointer)

The block pointer indicates which line of the program is currently being executed. It is shown as either a yellow or a red arrow.

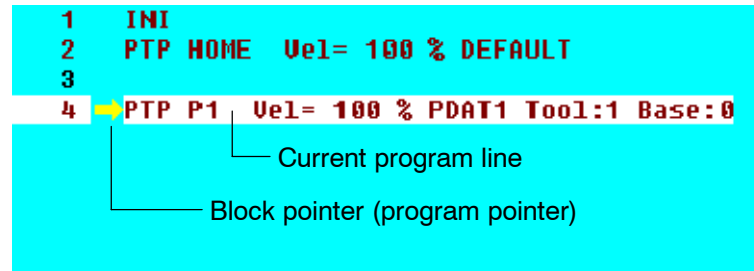

Line Sel.

If you want to place the block pointer on a particular line, first move the edit cursor to the desired position using the arrow keys “↑” or “↓”. Then press the softkey “Line Sel”. The block pointer is then placed on the selected line.



The block pointer is only available when a program has been selected, not in the editor.

The appearance of the block pointer changes to reflect whether or not the program line has already been executed.



L-shaped arrow (yellow):

The motion instruction is being executed in the forward direction, but has not yet been completed.



L-shaped arrow (yellow) with plus sign:

Here the block pointer is positioned on a closed fold. The motion instruction is being executed in the forward direction and has not yet been completed. This display is not available below the user group “Expert”.



Normal arrow (yellow):

The robot has completed the specified motion instruction in the forwards direction.



Normal arrow (yellow) with plus sign:

Here, too the block pointer is positioned on a closed fold. The motion instruction has been completed. This display is also not available below the user group “Expert”.



L-shaped arrow (red):

The motion instruction is being executed backwards, but has not yet been completed.



L-shaped arrow (red) with plus sign:

Here the block pointer is positioned on a closed fold. The motion instruction is being executed backwards and has not yet been completed. This display is not available below the user group “Expert”.



Normal arrow (red):

The robot has completed the specified motion instruction in the backwards direction.



Normal arrow (red) with plus sign:

Here, too the block pointer is positioned on a closed fold. The motion instruction has been completed. This display is also not available below the user group "Expert".

Edit cursor (Input mark)

The blinking edit cursor indicates the position in the program where changes are being made.

```

1  INI
2  PTP HOME Vel= 100 % DEFAULT
3
4  PTP P1 CONT Vel= 100 % PDAT1 Tool[1]:Dorn Base[0]
5  PTP P2 CONT Vel= 100 % PDAT2 Tool[1]:Dorn Base[0]
6  PTP P3 CONT Vel= 100 % PDAT3 Tool[1]:Dorn Base[0]

```

└── Edit cursor

Characters will, if possible, be inserted or deleted at this position. New commands, on the other hand, will be inserted below the edit cursor.

Direction indicator

This symbol is displayed if the block pointer is not visible in the program window.

```

19 GRIPPER INI

```

└── Direction indicator

The symbol indicates the required direction for scrolling to get back to the program pointer.



Double arrow (black) pointing up:

The block pointer is located higher up. Use the arrow key "↑" or "PGUP" to scroll up.



Double arrow (black) pointing down:

The block pointer is located lower down. Use the arrow key "↓" or "PGDN" to scroll down.

Line breaks

If the command line does not fit in the program window, a line break will be made automatically. This will be marked by a small black L-shaped arrow.

```

25 INTERRUPT DECL 15 WHEN
   ↳ $MEAS_PULSE[TOUCH_1[TOUCH_ACTIVE].IN_HR] DO H70 (6,C00 )

```

└── Line break



You can prevent the line break at expert level by activating the option "Configure" -> "Miscellaneous" -> "Editor" -> "Linebreak ON/OFF".

6.1.2 Program status line

The status line of a program which has been selected or which is in the editor shows the operator additional information about the program.

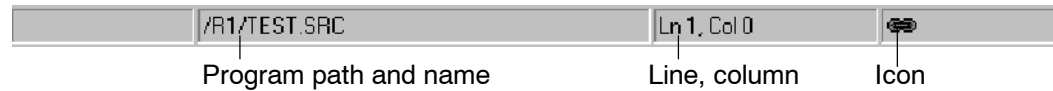

Program name

`/R1/TEST.SRC`

The path and the program name of the program which has been selected or is in the editor.

Line/column

`Ln 1, Col 0`

The current line and column position at which the edit cursor is located. Characters entered will, if possible, be inserted at this position.

Icon

Here the operator can obtain additional information about the loaded program or about program editing.



Padlock:

The file has been opened in write-protected mode. This means that no changes will be saved. A selected program, for example, cannot at the same time be processed in the editor. Likewise, no changes can be made if the opened file has been given the attribute "ReadOnly". If you nevertheless want to make corrections to the file, first remove the attribute "ReadOnly". To do this, use the option "File" -> "Attributes". Details can be found in the section "Navigator".



Chain:

The file indicated is selected or integrated into the selected program.



Clipboard:

Data have been copied to the clipboard; they can be inserted at another location. Copy functions are available only at the "Expert" user level and above.



ABC with check mark:

The option "Configure" -> "Miscellaneous" -> "Detail view" is activated. This function too is available only at the "Expert" user level and above.



PTP:

An existing inline form has been opened by pressing the softkey "Change".



PTP with star:

A new inline form has been opened.



Crossed-out (green) Start key:

The start interlock is active, i.e. the selected program cannot be started. This is the case for example when a motion command is being inserted or modified.



Question mark:

A query dialog in the message window must be responded to. For example, deletion of a block must first be confirmed by the operator.

6.2 Setting work velocity (program override)



In some cases, e.g. when testing programs, it is of vital importance to reduce the velocity of the robot. The “Program override” function, for which a status key can be found at the top right of the display, can be used for this purpose.

POV=100%

The value can be changed using the +/- key. The current setting is displayed both in the POV icon in the status key bar and in the status line.



Depending on the configuration, the program override is automatically set to a default value when the mode selector switch is switched to “T2”.



If you want to change the POV in larger steps, it is advisable to activate the option “Program-OV Steps on/off” in the menu “Configure” -> “Override”. The value is then no longer altered in increments of 1% but changes between 1, 3, 10, 30, 50, 75 and 100 per cent.

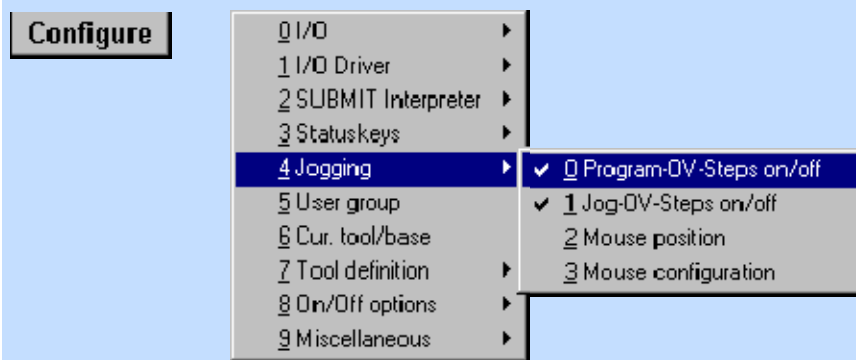

6.3 Stop reactions

If a running program is stopped, the EMERGENCY STOP button pressed or a safety gate opened, the robot is stopped. The controller distinguishes here between the following states:

6.3.1 Ramp-down braking

The robot is stopped with a normal braking ramp and remains on its programmed path. This occurs if...

- the “Program start forwards” or “Program start backwards” key has been released in jog mode, or
- the “Stop” key has been pressed in “Automatic” or “Automatic External” mode (passive stop);
- the driving condition is no longer present.

6.3.2 Path-maintaining Emergency Stop

The controller attempts to brake the robot on the path with a steeper braking ramp. This occurs if...

- the Emergency Stop button has been pressed in Automatic mode;
if the Emergency Stop ramp cannot be completed, short-circuit braking occurs.
- the enabling switch has been released;
if the path can no longer be held, the controller switches automatically to the “maximum braking” state.
- the safety gate to the work cell or the operator safety has been opened in automatic mode;
if the path can no longer be held, the controller switches automatically to the “maximum braking” state.
- the drives have been switched off during program execution;
if the path can no longer be held, the controller switches automatically to the “maximum braking” state.
- the operating mode has been changed during program execution;
if the path can no longer be held, the controller switches automatically to the “maximum braking” state.

6.3.3 Maximum braking

The robot is no longer on its path. This occurs if...

- an axis exceeds its command velocity or acceleration (the command velocity is lower in jog mode T1 than in T2 or automatic mode);
- a software limit switch has been reached or a command value has been exceeded.



In order to protect the brakes against overheating, the braking energy is calculated along with an associated cooling time.

If the braking energy exceeds a certain value, the drives are locked and a status message is generated in the message window. The message cannot be acknowledged until the motor brakes have cooled, and only then can the robot motion can be resumed.

6.3.4 Short-circuit braking (dynamic braking)

The robot is no longer on its programmed path and may have left its positioning window. This occurs if...

- the Emergency Stop button has been pressed in jog mode (T1 or T2);
- there is an encoder error;
- the controller is switched off or there is a power failure;
- the line between DSE and RDC has been interrupted.



In the event of short-circuit braking or dynamic braking, the holding brakes of the individual axes are applied while the motion is still in progress. If this happens frequently while the robot is still moving it leads to significantly increased wear on the holding brakes.



In order to protect the brakes against overheating, the braking energy is calculated along with an associated cooling time.

If the braking energy exceeds a certain value, the drives are locked and a status message is generated in the message window. The message cannot be acknowledged until the motor brakes have cooled, and only then can the robot motion be resumed.



The system variable "\$ON_PATH" provides information about whether the robot is on its programmed path ("TRUE") or not ("FALSE").

The positioning window is an area in space which can be likened to a tube around the programmed path. Its radius is defined in the system variable "\$NEARPATHTOL".



Further information can be found in the documentation **[Configuration]**, chapter **[Automatic External]** in the section **[Signal diagrams]**.

6.3.5 Warning and safety instructions



When safety devices are being used with "path-maintaining braking", it must be ensured that no-one enters the working range of the robot while the drives are on. The optional function "path-maintaining braking in event of operator safety violation" cannot be used in systems where there is a risk of people being situated in the working range of the robot during the deceleration time (these include, for example, light curtains in loading stations).



Before using the function "path-maintaining braking in event of operator safety violation", the user must carry out a danger analysis and a risk assessment for every eventuality.

6.4 Manual program execution (jog mode)

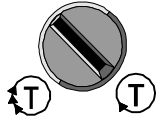

The descriptions in this section presuppose that a program has been selected. If this is not the case, please follow the procedure described in Section 6.1.

Set the mode selector switch to mode T1 or T2.



If the option “AutoAck” has been activated, all the acknowledgeable messages displayed are acknowledged when the Start key is pressed. These include all the actions which trigger the message “Active commands inhibited” (e.g. moving the robot with the traversing keys or the Space Mouse).

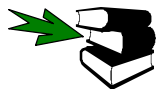

Further information about “AutoAck” can be found in the **Administrator** handbook.

6.4.1 Program run mode “Go”, “Single Step” or “I-Step”



If you want to execute a program fully, select the setting “Go”. Then hold down one of the enabling switches (on the back of the KCP) and press the “Program start forwards” key. The program is executed until either the Start key or the enabling switch is released.



If you want to execute a program step by step, choose the setting “Single Step”. Hold down one of the enabling switches (on the back of the KCP) and press the “Program start forwards” key. If the motion block has been completely executed, the “Start” key must be released and pressed again. The next motion block is then executed.



In expert mode, the option “Incremental Step” is also available. In this mode a program is executed one line at a time (this also applies for a closed fold, although at first glance nothing appears to be happening in such a case). In order to advance through the program the “Program start forwards” key must be released and pressed again at each step.



This symbol indicates reverse traversing using the “Program start backwards” key. This function cannot be switched manually but appears automatically when the “Program start backwards” key is pressed. Here again the “Program start backwards” key must be pressed after every motion command.



The “Program start forwards” key must be held down while the robot is moving, otherwise the program will be interrupted.

6.4.2 BCO run

For the purpose of ensuring that the robot position corresponds to the coordinates of the current program point, a so-called BCO run (block coincidence) is executed. This is carried out at reduced velocity (10%). The robot is moved to the coordinates of the motion block in which the block pointer is situated.

Time	no.	Source	Message
13:11 309 /			Block Select : BCO reaching in T1/T2 required

This is done...

- after a program reset by means of a BCO run to the home position;
- after block selection to the coordinates of the point at which the block pointer is situated;
- after selection of the "CELL" program before the Automatic External mode can be started;
- after a new program has been selected;
- after modifying a command;
- after manual traversing in programming mode.

A BCO run is also necessary if the tool center point is located outside the positioning window. The following examples are intended to illustrate this:



The tool center point is still located on the programmed path after the robot has stopped. A BCO run is not therefore required.

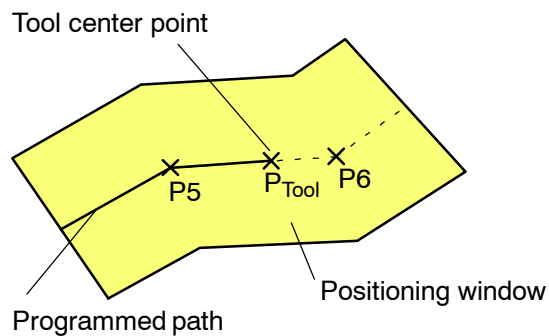



The tool center point is situated within the positioning window. A BCO run is not required here either.

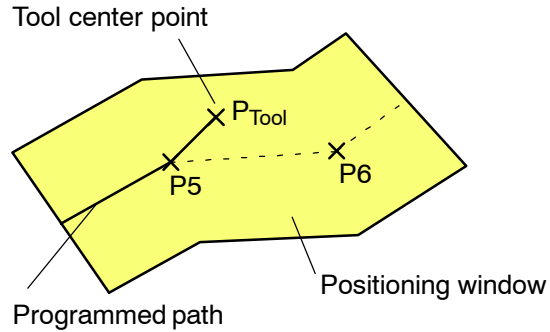

The robot has left the positioning window. A BCO run must be carried out.

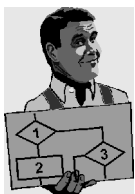
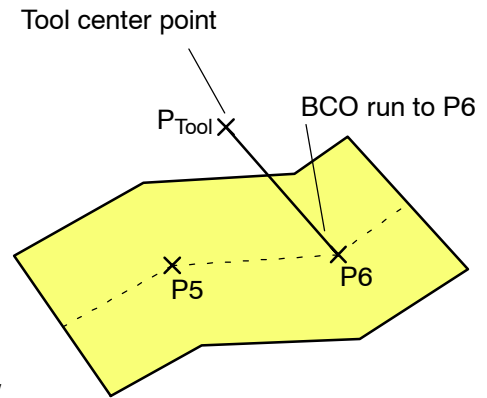
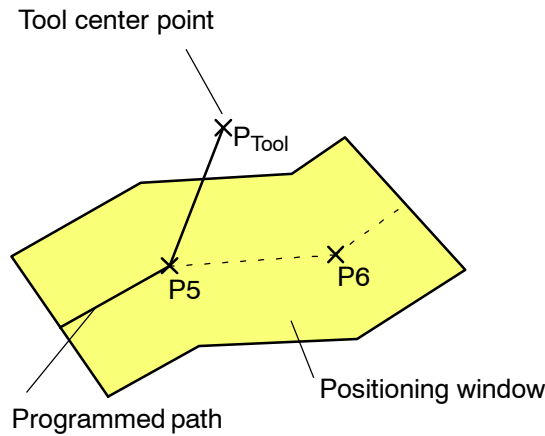

If a CIRC motion is left (e.g. through dynamic braking) the necessary BCO run is carried out directly to the next point.

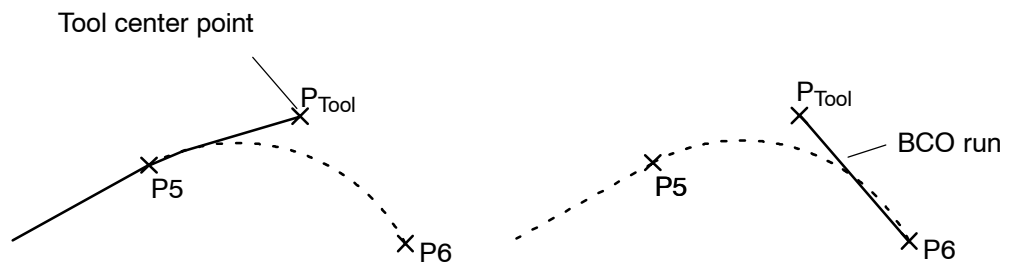

A BCO run always takes place by the direct route from the current position to the destination position. It is therefore important to make sure that there are no obstacles on this path in order to avoid damage to components, tools or the robot!

6.4.3 Executing individual program lines

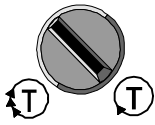

First of all ensure that the mode selector switch is in the jog mode position (T1 or T2). The program starts at the line indicated by the block pointer (yellow arrow) on the left.

File	Program	Configure	Monitor	Setup	Commands	Technology	Help
1	;EXT EXAMPLE1 ()						
2	;EXT EXAMPLE2 ()						
3	;EXT EXAMPLE3 ()						
4							
5	INIT						
6	BAS INI						
7	CHECK HOME						
8	PTP HOME Vel= 100 % DEFAULT						
9	AUTOEXT INI						
10	LOOP						
11	P00 (#EXT_PGNO,#PGNO_GET,DMV[],0)						
12	Block pointer (program pointer) h Programnummer						
13							
14	CASE 1						
15	P00 (#EXT_PGNO,#PGNO_ACKN,DMV[],0) ; Reset						
16	;EXAMPLE1 () ; Call User-Program						
17							
18	CASE 2						

Tl...	no.	Source	Message
!	14:05 1008	Controller	booted
!	14:08 47	BOF	PowerOn finished.
!	14:13 1356	HPU	Start key required

NUM	CAPS	S	I	R	/R1/CELL	Satz 5	T1	POV=100%	Rob_1	14:37
Change	Motion	Logic	Last Cmd.	Line Sel.	Touch Up	NAVIGATOR				



Program execution starts at the line indicated by the block pointer (yellow arrow) on the left. For the purpose of selecting a particular block in the program, move the edit cursor (vertical red line) to the desired program line with the aid of the arrow keys.

Line Sel.

This causes the block pointer to jump to the selected line. The block pointer jumps to the selected line.



Now start the program from the selected line. To do this, press one of the enabling switches (under the KCP) and the “Program start forwards” key.

During program execution, the program pointer (yellow arrow) always moves to the line that is currently being executed.

```

3 PTP P1 Vel= 100 % PDAT1
4 WAIT FOR IN 1 'Freigabe' State= TRUE
5 PTP P2 Vel= 100 % PDAT2
6 WAIT FOR IN 2 'Peripherie' State= TRUE
7 PTP P3 Vel= 100 % PDAT3
    
```



The first program step usually consists of a “BCO run” and must be triggered by pressing an enabling switch and the Start key. When block coincidence is reached a corresponding message is generated. At the start of the actual program, release the Start key briefly and press it again.

Ti...	Nr.	Src.	Message
12:56	1356	HPU	Start key required
12:56	1350		Programmed path reached [BCO]



The “Program start forwards” key must be held down while the robot is moving, otherwise the program will be interrupted.

6.4.4 Program start backwards

Using the “Program start backwards” key, a program can be executed in the reverse sequence.



For reverse traversing, only the operating modes “Test (T1/T2)” are available.



When the “Program start backwards” key is pressed, all outputs, flags and cycflags are handled according to the configuration in the Backward.ini file.

1	INI	
2	PTP HOME	Vel= 100
3	PTP P5	Vel= 100 %
4	PTP P1	Vel= 100 %
5	PTP P2	Vel= 100 %

If a program is executed using the “Program start forwards” key, the yellow block pointer indicates the last motion block addressed.



1	INI	
2	PTP HOME	Vel= 100
3	PTP P5	Vel= 100 %
4	PTP P1	Vel= 100 %
5	PTP P2	Vel= 100 %

When the “Program start backwards” key is pressed, the “Program run mode” status key switches to reverse traversing.

The block pointer, which is now red, then indicates the last motion block addressed backwards.



Once the corresponding motion block has been reached, the “Program start backwards” key must be released and pressed again. The next motion block is then addressed.

Forwards and reverse traversing are only possible if BCO (block coincidence) exists.

In the case of reverse traversing, all programmed points are addressed with exact positioning. Approximate positioning is not possible here.



If the robot is moved backwards inside an approximate positioning range, the exact positioning point of the approximate positioning range is addressed.

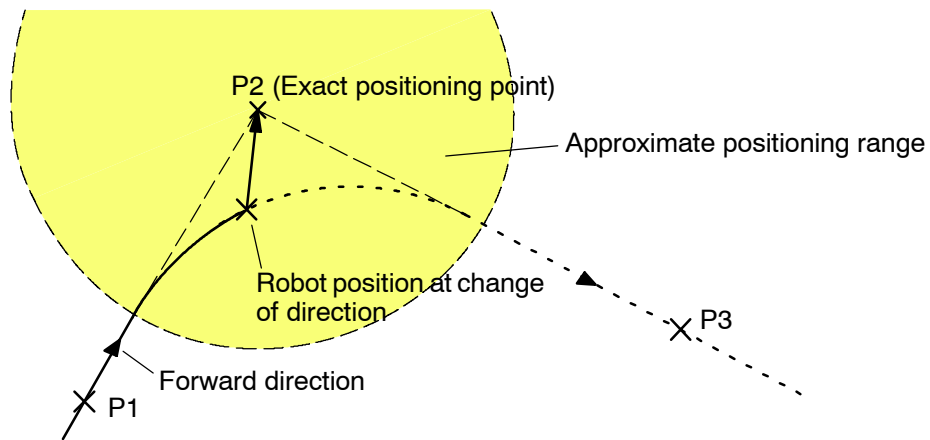

Overlapping motions, e.g. weaving or sensor corrections, are not supported during reverse traversing.



If the direction is changed from backwards to forwards between two points, the outputs of the preceding block are not restored.

6.4.5 Stopping program execution

To stop the program in the jog mode, release the Start key. The program will be stopped immediately.

6.4.6 Resetting a program (Reset)



With the menu function “Program” → “Reset program”, a program that has been stopped or interrupted can be returned to the initial state it had when loaded.

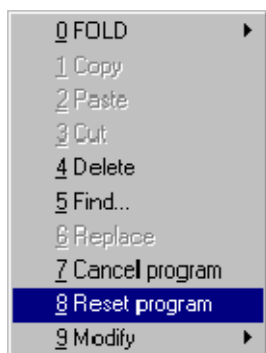

The yellow block pointer then jumps to the first instruction that can be executed in the indicated program. The selected program can subsequently be restarted.

```

1  → [NI]
2  PTP HOME Vel= 100 % DEFAULT
3  PTP P1 Vel= 100 % PDAT1
4  WAIT FOR IN 1 'Freigabe' State= TRUE
    
```



After the program has been reset, a BCO run is carried out. This always takes place by the direct route from the current position to the home position or to the next point. It is therefore important to make sure that there are no obstacles on this path in order to avoid damage to components, tools or the robot!

6.4.7 Continuing a program



A program that has been stopped or interrupted can be continued by holding down an enabling switch and pressing the Start key.

6.5 Automatic program execution



In normal robot operation, a program is executed cyclically, i.e. when the end of the program is reached, program execution automatically continues from the beginning of the program.

The following descriptions presuppose that a program has been selected. If this is not the case, please follow the procedure described in Section 6.1.



Switch the drives of the robot on.



When a program is running, the menu commands “Configure” -> “I/O Driver” -> “Driver Reset” and “I/O Reconfigure” are deactivated and cannot be used.

6.5.1 BCO run

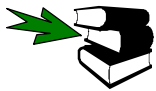

Further information can be found in the section **[Manual program execution]**.

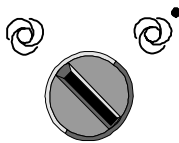

Set the mode selector switch to “Automatic” or “Automatic External” mode.

The status line then changes for automatic mode as follows:

↓

NUM	CAPS	S	I	R	/R1/CELL	Line 5	AUT	POV=100%	Rob_1	13:09
-----	------	---	---	---	----------	--------	-----	----------	-------	-------

In Automatic External mode, the status line has the following appearance:

↓

NUM	CAPS	S	I	R	/R1/CELL	Line 5	EXT	POV=100%	Rob_1	13:09
-----	------	---	---	---	----------	--------	-----	----------	-------	-------

6.5.2 Stopping program execution



A program can be stopped by pressing the “Program stop” key. The program and the robot are then stopped.

	Ti..	Nr.	Src.	Message
!	13:04	1367	HPU	ACTIVE status required
!	13:04	1367	HPU	ACTIVE status required
!	13:05	209		Passive stop HPU
!	13:05	1370	HPU	Passive STOP



If the drives of the robot have been switched off by means of the “Drives OFF” key, the robot stops and the brakes of the axes are engaged.

6.5.3 Continuing a program



If the drives of the robot have been switched off by means of the “Drives OFF” key, the drives must first be switched on again before the program can be restarted. This is done by pressing the “Drives ON” key.

Operator Control

Ack

If the acknowledgement message for a passive stop is displayed in the message window it must be acknowledged.

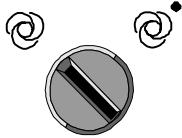

	Time	No.	Src.	Message
!	13:04	1367	HPU	ACTIVE status required
!	13:04	1367	HPU	ACTIVE status required
f	13:05	209		Passive stop HPU
STOP	13:05	1370	HPU	Passive STOP

The mode must then be set back to “Automatic” or “Automatic External”.

6.6 Deselecting a program

Program

If you want to deselect a program, press the menu key “Program”. Select the option “Cancel program” from the menu that is opened.

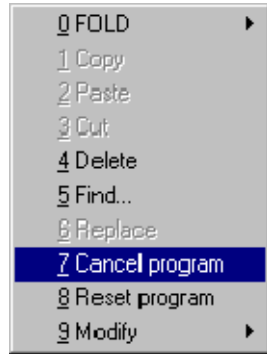

To check that the program has been deselected, please ensure that the name of the previously selected program no longer appears in the status bar.



7 Monitor

A wide range of functions are grouped together under the menu item “Monitor” giving you an overview of operating states and settings of the robot system.

Monitor

After selecting the menu key, this menu is opened:



The individual menu options are described in more detail in the following sections.



More detailed information about the handling of menus, inline forms and status windows can be found in the chapter **[The KUKA Control Panel KCP]**.

7.1 Inputs/outputs

All of the available inputs and outputs can be viewed and some of them also altered by choosing the menu item “I/O”.

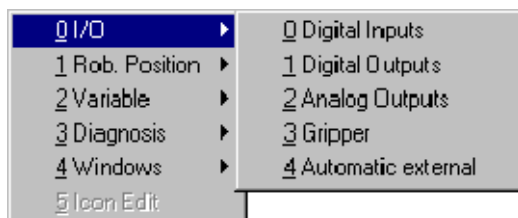

7.1.1 Digital inputs

Once this option has been selected a status window is opened, displaying the signal states of the robot controller's inputs and the configured long texts.

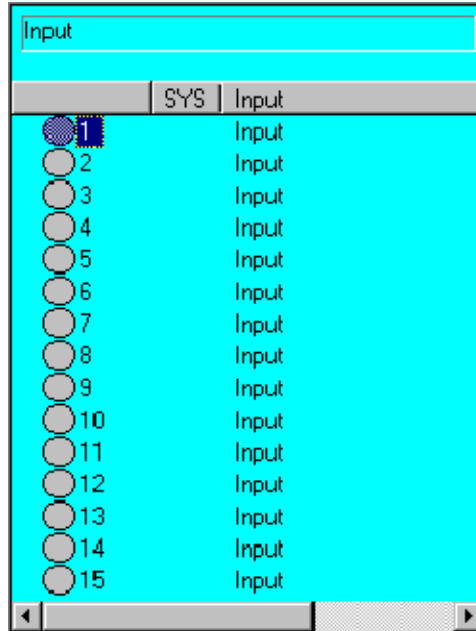

New Name

The name of an input can be changed by pressing the softkey "New Name". This information is saved in the long text database and is thus available again next time the status window is opened.

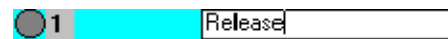















Outputs

You can open the status window for displaying the 1024 outputs with the aid of the softkey "Outputs". When you have pressed the softkey, its label and function change. You can return to the status window for displaying inputs by pressing it again.



You can access the desired input directly via the numeric keypad by entering the corresponding number (e.g. 524) and waiting.

Inputs can be simulated, i.e. set to fixed values, for the purposes of commissioning or in the event of errors arising. This makes it possible to test robot programs even if the connected peripheral equipment is not (yet) operational. This function can only be configured at Expert level.

Input			
	SYS	SIM	Input
			Input
			Input
		SIM	Input
		SIM	Input
		SIM	Input
			Input
			Input
			Input
	SYS		Input
			Input
		SIM	Input
		SIM	Input
			Input
			Input
			Input

The designation "SIM" identifies simulated inputs which may be either set or not set.

The designation "SYS" identifies inputs whose value are saved in a system variable.

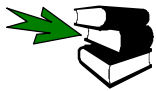

Further information...

...on simulation of inputs and outputs can be found in the **Programming Handbook** in the documentation **[Configuration]**, chapter **[Configuring the system, expert]**, section **[Simulated inputs/outputs]**.

...on the subject of system variables can be found in the **Programming Handbook** in the documentation **[Expert Programming]**, chapter **[Variables and declarations]**, section **[System variables and declarations]**.

7.1.2 Digital outputs

After this option has been selected a status window is opened, displaying the signal states of the robot controller's outputs.

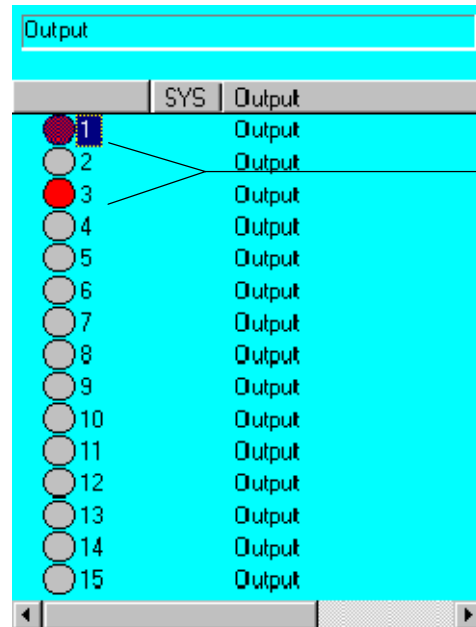

The red LED symbol indicates that these outputs are set.

New Name

The name of an input can be changed by pressing the softkey "New Name". This information is saved in the long text database and is thus available again next time the status window is opened.

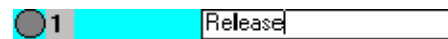

Change

You can switch the output on which the color marker bar is located by pressing the softkey "Change". This softkey can only be used as long as one of the enabling switches on the rear of the KCP is held down. Furthermore, it is not displayed in the operating mode "Automatic".















Inputs

You can open the status window for displaying the 1024 inputs with the aid of the softkey "Inputs". When you have pressed the softkey, its label and function change. You can return to the status window for displaying outputs by pressing it again.



You can access the desired output directly via the numeric keypad by entering the corresponding number (e.g. 524) and waiting. To do this, the function "NUM" must be activated in the status line.

Outputs can be simulated, i.e. set to fixed values, for the purposes of commissioning or in the event of errors arising. This makes it possible to test robot programs even if the connected peripheral equipment is not (yet) operational. This function can only be configured at Expert level.

Output			
	SYS	SIM	Output
 995	SYS		Output
 996	SYS		Output
 997	SYS		Output
 998		SIM	Output
 999		SIM	Output
 1000	SYS		Output
 1001	SYS		Output
 1002			Output
 1003			Output
 1004		SIM	Output
 1005		SIM	Output
 1006			Output
 1007			Output
 1008			Output
 1009			Output

The designation "SIM" identifies simulated outputs which may be either set or not set.

The designation "SYS" identifies outputs whose value are saved in a system variable.

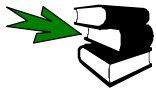

Further information...

...on simulation of inputs and outputs can be found in the **Programming Handbook** in the documentation [**Configuration**], chapter [**Configuring the system, expert**], section [**Simulated inputs/outputs**].

...on the subject of system variables can be found in the **Programming Handbook** in the documentation [**Expert Programming**], chapter [**Variables and declarations**], section [**System variables and declarations**].

7.1.3 Analog Outputs

After this option has been selected a status window is opened, displaying the values of the 32 analog outputs.

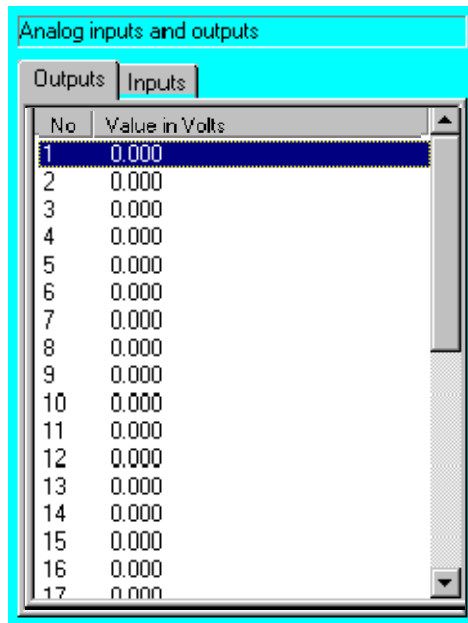

The output values (ranging from -10 V to +10 V) are displayed in the boxes.

Tab +

You can open the status window for displaying the 32 analog inputs with the aid of the softkey "Tab +". The values of these inputs cannot be changed.

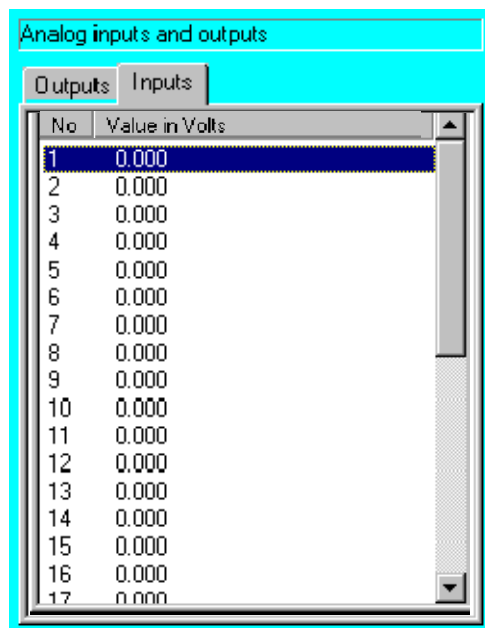

You can return to the status window for displaying the 32 outputs by pressing the softkey "Tab +" again.

Change

When the softkey "Change" is pressed, the input box selected using the arrow keys is opened. Enter the new value by means of the numeric keypad.

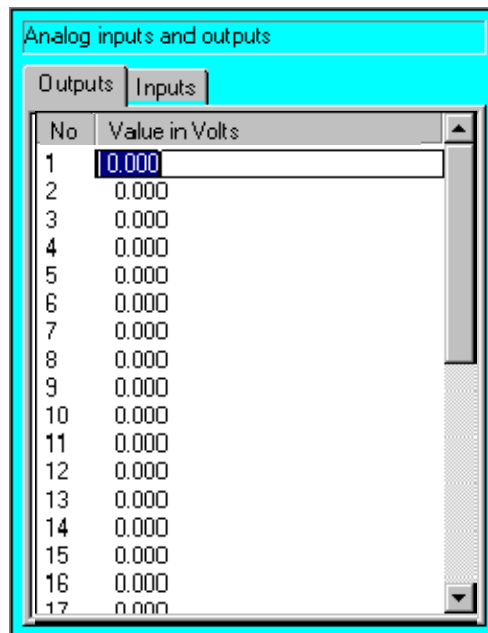

Analog inputs and outputs

Outputs Inputs

No	Value in Volts
1	0.000
2	0.000
3	0.000
4	0.000
5	0.000
6	0.000
7	0.000
8	0.000
9	0.000
10	0.000
11	0.000
12	0.000
13	0.000
14	0.000
15	0.000
16	0.000
17	0.000

OK

Press the softkey "OK" in order to let the new settings take effect. The input box closes again.

7.1.4 Gripper

After this option has been selected a status window is opened, displaying the signal states of configured grippers.

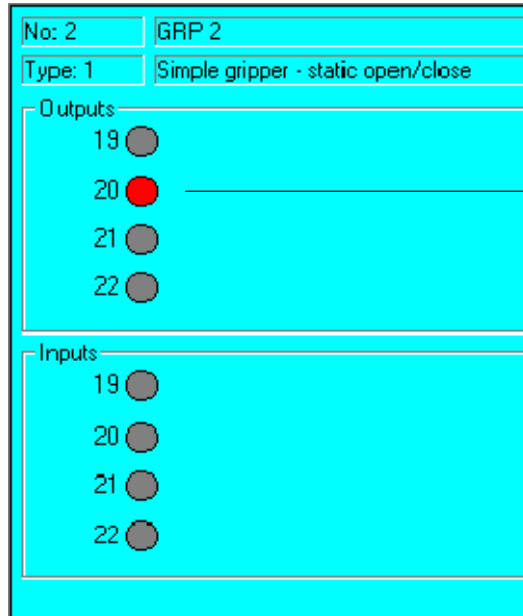

The red LED symbol indicates that this output is set.



The softkeys and status keys described below are only displayed if they have been activated via the menu item **Configure/Status keys/GRIPPERTech**.



The number and type of gripper that have been selected with the status key "Gripper" are displayed in the top line of the status window.



Using the status key "Manual gripper operation", you can switch between the configured functions of the selected gripper. To do this, one of the enabling switches on the back of the KCP must be held down.



A configured gripper can only be operated in the mode T1 (reduced velocity) or T2 (programmed velocity), with the enabling switch located on the back of the KCP held down.

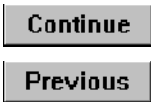

You can use the two softkeys "Continue" and "Previous" or the status key "Gripper" to page through the available gripper forms. The indication of the gripper number on the status key "Gripper" does not change in this case.

7.1.5 Automatic External

After this option has been selected a status window is opened, in which the signal states of the “Automatic External” interface can be displayed.

7.1.5.1 Inputs

Automatic External - Monitor: Inputs		
	St.	Term
1	0	current programno.
2	<input type="radio"/>	Type programno.
3	<input type="radio"/>	Bitwidth programno.
4	<input type="radio"/>	First bit programno.
5	<input type="radio"/>	Parity bit
6	<input type="radio"/>	Programno. valid
7	<input type="radio"/>	Programstart
8	<input checked="" type="radio"/>	Move enable
9	<input type="radio"/>	Error confirmation
10	<input checked="" type="radio"/>	Drives off (invers.)
11	<input type="radio"/>	Drives on
12	<input checked="" type="radio"/>	Activate interface

Status gray: No signal present at this input (FALSE)

Status red: Signal present at this input (TRUE)

Move enable Term: Description of the input currently being used

Details

The softkey “Details” changes to a different status window displaying more information: the type, the name of the variable and the channel number or value.

Automatic External - Monitor: Inputs					
	St.	Term	Type	Name	Value
1	0	current programno.	Var	PGND	
2	<input type="radio"/>	Type programno.	IO	PGND_TYPE	1
3	<input type="radio"/>	Bitwidth programno.	IO	PGND_LENGTH	8
4	<input type="radio"/>	First bit programno.	IO	PGND_FBIT	33
5	<input type="radio"/>	Parity bit	IO	PGND_PARITY	41
6	<input type="radio"/>	Programno. valid	IO	PGND_VALID	42
7	<input type="radio"/>	Programstart	IO	\$EXT_START	1026
8	<input checked="" type="radio"/>	Move enable	IO	\$MOVE_ENABLE	1025
9	<input type="radio"/>	Error confirmation	IO	\$CONF_MESS	1026
10	<input checked="" type="radio"/>	Drives off (invers.)	IO	\$DRIVES_OFF	1025
11	<input type="radio"/>	Drives on	IO	\$DRIVES_ON	140
12	<input checked="" type="radio"/>	Activate interface	IO	\$I_O_ACT	140



The type can be a variable (yellow) or an input (green).

PGNO_TYPE The variable or system variable (“\$”) or the name of the input

140 The value of the input or the channel number

Normal “Normal” switches back to the short version of the display.

Outputs The softkey “Outputs” takes you to the corresponding page.

Close The status window is closed by means of the softkey “Close”.

7.1.5.2 Outputs

Start conditions

This page contains all the status information relevant to the start.

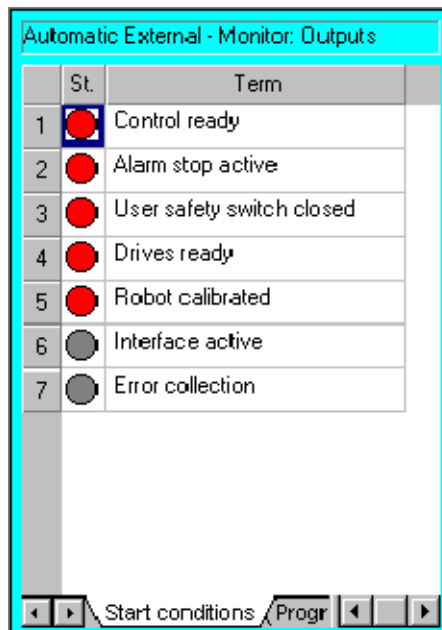

● Status gray: No signal present at this output (FALSE)

● Status red: Signal present at this output (TRUE)

Drives ready Term: Description of the output currently being used

Tab+ You can page through the various pages of the “Outputs” display with the aid of the softkeys “Tab+” and “Tab-”.

Tab-

Details The softkey “Details” changes to a different status window displaying more information: the type, the name of the variable and the relevant output.

Automatic External - Monitor: Outputs					
	St.	Term	Type	Name	Value
1		Control ready		\$RC_RDY1	137
2		Alarm stop active		\$ALARM_STOP	1013
3		User safety switch closed		\$USER_SAF	1011
4		Drives ready		\$PERI_RDY	1012
5		Robot calibrated		\$ROB_CAL	1001
6		Interface active		\$I_O_ACTCONF	140
7		Error collection		\$STOPMESS	1010

Navigation: Start conditions / Program state / Robot position / Operation



The type can only be an output (green).

\$ALARM_STOP

The variable or system variable (“\$”)

140

The value of the output being used

Normal

“Normal” switches back to the short version of the display.

Inputs

The softkey “Inputs” takes you to the corresponding page.

Close

The status window is closed by means of the softkey “Close”.

Program state

This page contains all the variables that are relevant to the program state.

Automatic External - Monitor: Outputs					
	St.	Term	Type	Name	Value
1	<input checked="" type="radio"/>	Program activ	NO	\$PRO_ACT	
2	<input type="radio"/>	Programno. request	NO	PGNO_REQ	33
3	<input type="radio"/>	Application runs	NO	APPL_RUN	34
4	<input type="radio"/>	Program move activ	NO	\$PRO_MOVE	

Navigation: Start conditions | Program state | Robot position | Operator

Robot position

Here you will find a list of robot positions including, for example, the various HOME positions.

Automatic External - Monitor: Outputs					
	St.	Term	Type	Name	Value
1	<input checked="" type="radio"/>	In Home position	NO	\$IN_HOME	
2	<input checked="" type="radio"/>	1. Home position	NO	\$IN_HOME1	
3	<input checked="" type="radio"/>	2. Home position	NO	\$IN_HOME2	
4	<input checked="" type="radio"/>	3. Home position	NO	\$IN_HOME3	
5	<input checked="" type="radio"/>	4. Home position	NO	\$IN_HOME4	
6	<input checked="" type="radio"/>	5. Home position	NO	\$IN_HOME5	
7	<input type="radio"/>	Robot on path	NO	\$ON_PATH	
8	<input type="radio"/>	Robot near path	NO	\$NEAR_POSRET	
9	<input checked="" type="radio"/>	Robot stopped	NO	\$ROB_STOPPED	

Navigation: Start conditions | Program state | Robot position | Operator

Operation mode

The operating mode currently active is displayed on the last page.

Automatic External - Monitor: Outputs					
	St.	Term	Type	Name	Value
1	<input checked="" type="radio"/>	Test1-Operation mode	IND	\$T1	
2	<input type="radio"/>	Test2-Operation mode	IND	\$T2	
3	<input type="radio"/>	Automatic-Operation mode	IND	\$AUT	
4	<input type="radio"/>	Automatic External	IND	\$EXT	

Navigation: < | > | Conditions | Program state | Robot position | **Operation mode** | < | >

7.2 Rob. Position

Monitor

You can display the position of the robot by using the menu item “Rob. Position”.

The following position displays can be selected:

7.2.1 Cartesian

This status window displays the current position of the robot in Cartesian mode. If the status window remains open, you can constantly follow the position and orientation while the robot is in motion.

Position: [mm]	
X	1620.001000
Y	0.000000
Z	1910.000000
Orientation: [deg]	
A	0.000000
B	90.000000
C	0.000000
Robot position: [bin]	
S	010
T	000010

Cartesian display

With this display mode, the position of the tool center point (TCP) is displayed in relation to the WORLD coordinate system in the base of the robot and the rotational offset between the two coordinate systems. The entries for “Status” and “Turn” are also displayed.

Cartesian

Axis spec.

Increment

Close

You can switch between the various windows at any time by pressing the softkeys “Cartesian”, “Axis spec.” and “Increment”.

You can exit and close the status window by pressing the softkey “Close”.

7.2.2 Joint

This status window displays the current position of the robot in joint (axis-specific) mode. If the status window remains open, you can constantly follow the values of the axis angles while the robot is in motion.

Axis Angle	[deg]
A1	-0.003231
A2	-89.791420
A3	89.934400

	[deg]
A4	1.173358
A5	0.804593
A6	-0.921746

Axis-specific (joint) display

The rotational offset of each robot axis is displayed here in relation to its zero position determined during mastering.

Cartesian

Axis spec.

Increment

Close

You can switch between the various windows at any time by pressing the softkeys "Cartesian", "Axis spec." and "Increment".

You can exit and close the status window by pressing the softkey "Close".

7.2.3 Incremental

This status window displays the current position of the robot in increments. If the window remains open, you can read the current display while the robot is in motion.

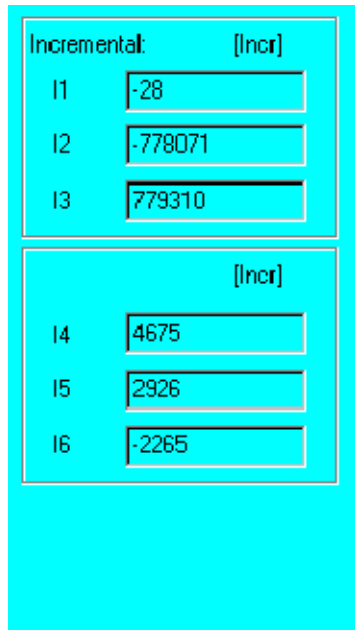

Incremental display

Values for the increments supplied by the axis drives are displayed here.

- Cartesian**
- Axis spec.**
- Increment**
- Close**

You can switch between the various windows at any time by pressing the softkeys "Cartesian", "Axis spec." and "Increment".

You can exit and close the status window by pressing the softkey "Close".

7.2.4 Master/slave display

Display of axis 1

Master/Slave	[Incr]
M:	779310
S1:	779310
S2:	Not present
S3:	Not present
S4:	Not present
S5:	Not present

The angular momentum of the master/slave drives is shown in this status window.

Mas./Slave

Cartesian

Axis spec.

Increment

Close

You can switch between the display modes at any time by pressing the softkeys “Mas./Slave”, “Cartesian”, “Axis spec.” and “Increment”.

You can exit and close the status window by pressing the softkey “Close”.



The softkey “Mas./Slave” and the associated status window are only displayed if the corresponding options are installed.



If the status window remains open, you can constantly follow the position and orientation while the robot is in motion.

7.3 Variable

7.3.1 Single

After this option has been selected a status window is opened, in which the values of the variables are displayed and can be altered.

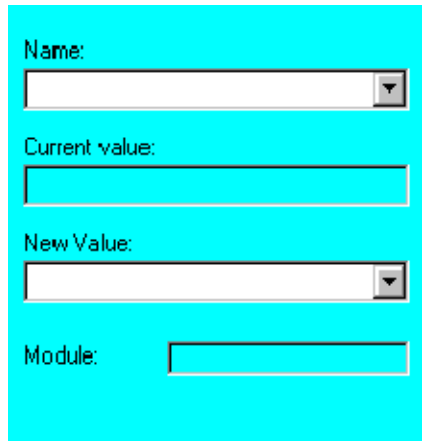

The screenshot shows a status window with four input fields: "Name:" (a list box), "Current value:" (a text box), "New Value:" (a list box), and "Module:" (a text box). All fields are currently empty.



List boxes are opened by means of the key combination **ALT + ↓**.

Name

To change the value of a variable, position the cursor in the input box "Name", using the softkey "Name" and enter the name of the variable you wish to change. Then press the Enter key to confirm this.

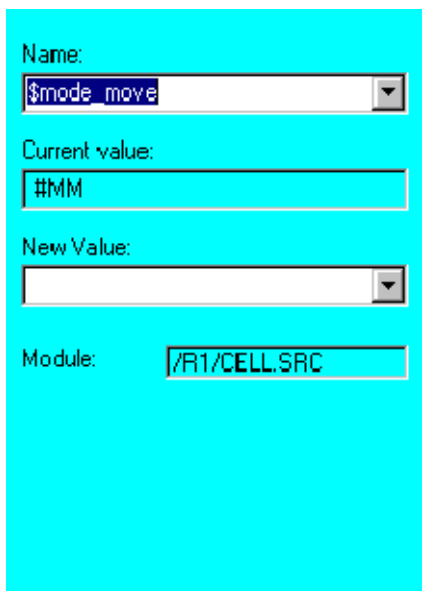

The screenshot shows the same status window as before, but now the "Name:" list box contains the text "\$mode.move" and the "Current value:" text box contains "#MM".

The value the variable had when you pressed the Enter key is now displayed in the box "Current value". If this is not the case, please check the messages in the message window.

As long as the cursor remains in the box "Current value", the arrow keys "↓" and "↑" can be used to scroll through the list of variables being edited and/or displayed.

New Value

Now press the softkey "New Value" to position the cursor in the input box "New Value". Enter the new value for the variable and confirm this by pressing the Enter key again.



The screenshot shows a control panel with the following fields:

- Name:** A dropdown menu with the value "\$mode_move".
- Current value:** A text input field containing "#MM".
- New Value:** A dropdown menu with the value "#MI".
- Module:** A text input field containing "/R1/CELL.SRC".

After your entry has been accepted by the controller, the new value is displayed in the box "Current value". If this is not the case, please check the messages in the message window.

In the basic setting, the search for the specified variable begins in the program currently selected. If it is not found here, all global data lists are searched.

Module

If you wish to search for the variable in a program other than the one currently selected, you need to press the softkey "Module". The input box of the same name is opened. Enter the file path here for the program you wish to search.

7.3.2 Overview

7.3.2.1 Monitor

After this option has been selected a status window is opened. The groups of variables entered in the file `ConfigMon.ini` are displayed here.

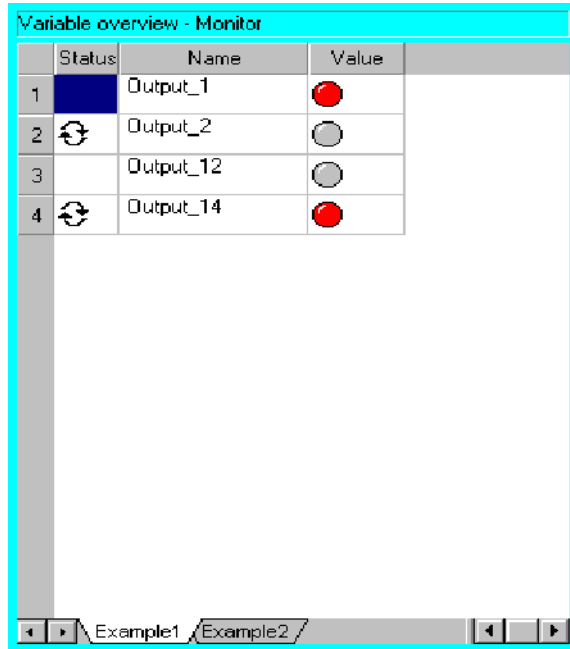

The box "Status" indicates whether or not the line is updated automatically. This symbol is displayed if the display is updated automatically.

Output_1

The name of the input or output is displayed in the box "Name".

If the box "Variable" exists, the name of the corresponding system variable is displayed.



Value gray: No signal present at the input or output (FALSE)



Value red: Signal present at the input or output (TRUE)

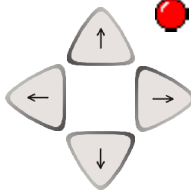

The arrow keys can be used to select a specific element in the group and make certain modifications. This is done by pressing the softkey "Change".



It is possible to see from the tabs at the bottom of the status window whether or not further display groups are available.

Tab +

If there is at least one other group available, you can toggle to this page using the softkey "Tab+". Otherwise, this softkey is deactivated.

Config.

The softkey "Config." is available in the user group "Expert" or higher and enables the configuration of individual groups.

Refresh all

The softkey "Refresh all" is used to update the display.

start info

The softkey "start info" activates the automatic updating of the selected element. "Cancel Info" can be used to deactivate the continuous automatic updating function.

Cancel Info

Change

Elements selected using the arrow keys can be modified by pressing the softkey “Change”. This applies to the names of inputs/outputs and the setting of outputs to “TRUE” or “FALSE”.

OK

The softkey “OK” is used to accept the changes that have been made.

Cancel

The softkey “Cancel” is used to reject the changes.

Save

Pressing “Save” saves the current changes in the file “ConfigMon.ini” and closes the status window. The changes that have been saved are displayed again next time the window is opened.

Cancel

The variable display is closed using the softkey “Cancel”.



The values of write-protected variables cannot be changed.

If the current user group is lower than the entry in the “ConfigMon.ini” file, under “Editable”, the softkey “Change” cannot be pressed.

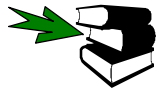

Information on configuring the display via the “ConfigMon.ini” file can be found in the **Programming Handbook** in the documentation [**Configuration**], chapter [**Configuring the system, Expert**].

7.3.2.2 Configure

This menu item is not available below the user group “Expert”.

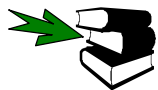

Information on this command can be found in the **Programming Handbook** in the documentation [**Configuration**], chapter [**Configuring the system, Expert**].

7.3.2.3 Display

This menu item is also not available below the user group “Expert”.

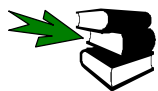

Information on this command can be found in the **Programming Handbook** in the documentation [**Configuration**], chapter [**Configuring the system, Expert**].

7.3.3 Cyclic Flags

After this option has been selected a status window is opened, displaying the signal states of the 32 cyclical flags, also called “Notices”.

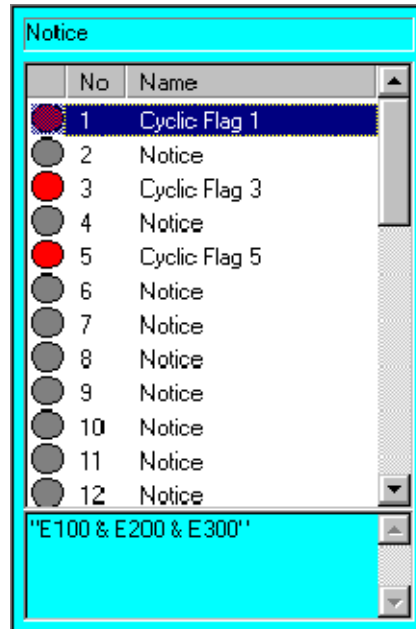

 Gray: The cyclical flag is not set

 Red: The cyclical flag is set

 2 The number of the cyclical flag in question is displayed in the box “No”.

 Cyclic Flag A description of the cyclical flag is displayed in the box “Name”.

 E100 & E200 The text stored for this cyclical flag is displayed in the lower section of the window.

Change

The name of the cyclical flag selected using the arrow keys can be modified by pressing the softkey “Change”; up to 40 characters are permitted here.



OK

The softkey “OK” is used to accept the changes that have been made.

Cancel

The softkey “Cancel” is used to reject the changes.

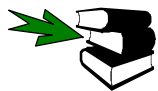



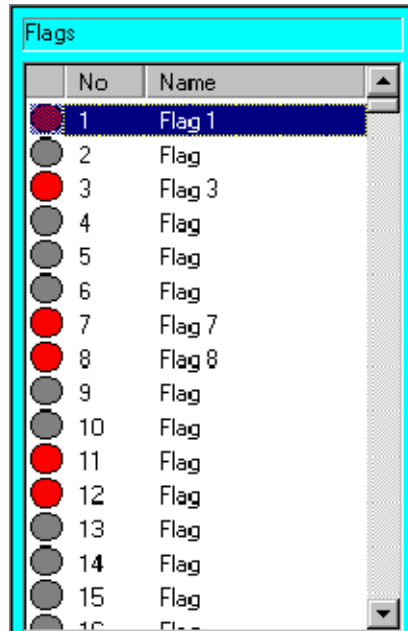

More detailed information on the use and programming of cyclical flags can be found in the Programming Handbook in the documentation **[Expert Programming]**, in the chapter **[Variables and declarations]**, section **[System variables and system files]** and in the chapter **[Interrupt handling]**, section **[Use of cyclical flags]**.

7.3.4 Flags

After this option has been selected a status window is opened, displaying the states of all 999 flags.



-  Gray: The flag is not set
-  Red: The flag is set
-  2 The number of the flag in question is displayed in the box "No".
-  Flag The name of the flag is displayed in the box "Name".

Change

You can switch the flag on which the color marker bar is located by pressing the softkey "Change".

Name

The name of the flag selected using the arrow keys can be modified by pressing the softkey "Name"; up to 40 characters are permitted here.



OK

The softkey "OK" is used to accept the changes that have been made.

Cancel

The softkey "Cancel" is used to reject the changes.



More detailed information on the use and programming of flags can be found in the **Programming Handbook** in the documentation **[Expert Programming]**, in the chapter **[Variables and declarations]**, section **[System variables and system files]**.

7.3.5 Counter

After this option has been selected a status window is opened, displaying the values of the counters already configured.

N...	Value:	Name
1	256	Name of the Counter
2	0	Counter
3	0	Counter
4	0	Counter
5	0	Counter
6	25	Counter
7	0	Counter
8	0	Counter
9	0	Counter
10	0	Counter

Value

After pressing the softkey "Value", you can enter a new value for the selected counter using the numeric keypad.

1 256 Name of the Counter

OK

The softkey "OK" is used to accept the changes that have been made.

Cancel

The softkey "Cancel" is used to reject the changes.

Name

The name of the counter can be modified using the softkey "Name". The name may consist of a maximum of 40 characters.

1 256 Name of the Counter

OK

The softkey "OK" is used to accept the changes that have been made.

Cancel

The softkey "Cancel" is used to reject the changes.



If you close the status window without having pressed the softkey "OK" beforehand, the changes will not be saved.

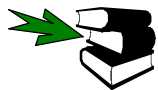

More detailed information on the use and programming of counters can be found in the **Programming Handbook** in the documentation **[Expert Programming]**, in the chapter **[Variables and declarations]**, section **[Boxes]**.

7.3.6 Timer

After this option has been selected a status window is opened, displaying the values and operating states of all 10 timers.

State	No	Value[ms]	Name
	1	5004	Timer 1
	2	0	Timer 2
	3	5604	Timer
	4	559056	Timer
	5	0	Timer
	6	0	Timer
	7	0	Timer
	8	0	Timer
	9	0	Timer
	10	0	Timer

- Red: This timer is deactivated and set to a value ≤ 0
- Red with check: This timer is deactivated and set to a value > 0
- Green: This timer is activated and running in the range ≤ 0
- Green with check: This timer is activated and running in the range > 0

Change

The softkey "Change" starts the selected timer or stops one that is running.

Value

After pressing the softkey "Value", you can enter a new value for the selected timer using the numeric keypad.

	1	<input type="text" value="5004"/>
--	---	-----------------------------------

OK

The softkey "OK" is used to accept the changes that have been made.

Cancel

The softkey "Cancel" is used to reject the changes.

Name

The name of the timer can be modified using the softkey "Name". The name may consist of a maximum of 40 characters.

	1	5004	<input type="text" value="Timer 1"/>
--	---	------	--------------------------------------

OK

The softkey "OK" is used to accept the changes that have been made.

Cancel

The softkey "Cancel" is used to reject the changes.



If you close the status window without having pressed the softkey "OK" beforehand, the changes will not be saved.



More detailed information on the use and programming of timers can be found in the **Programming Handbook** in the documentation **[Expert Programming]**, in the chapter **[Variables and declarations]**, section **[Timer]**.

7.4 Diagnosis

The following functions are grouped together under the menu item “Monitor” -> “Diagnosis”:

Menu	Function
Oscilloscope	Recording and displaying motion data or the signal states of inputs and outputs.
Log book	Displaying logged operator actions on the KCP.
CROSS Log book (only in “Expert” mode)	Displaying log files of the trace program “KUKA Cross” that runs in the background and (depending on the configuration) records a number of actions.
Caller Stack (only in “Expert” mode)	Menu-assisted monitoring of the advance run and main run pointers, and also “Arrived at point” and “Move to point”.
Interrupts (only in “Expert” mode)	List of all declared robot and submit interrupts.
Securitycircuit (safety circuit)	Starting the ESC diagnostic program which can be used to check the safety circuit of the robot.
Web Diagnosis	Web-based diagnosis

Monitor

The diagnostic functions are accessed by pressing the menu key “Monitor” and then selecting the submenu “Diagnosis”.

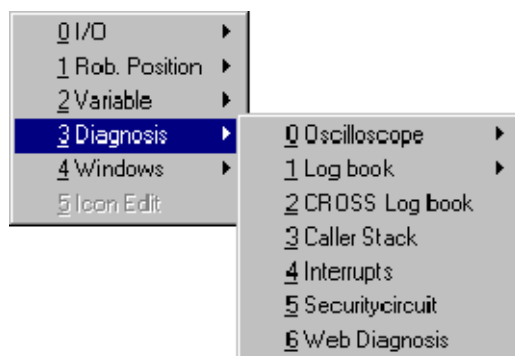

Select the desired diagnosis function from the open submenu.



The menu items “CROSS Logbook”, “Caller Stack” and “Interrupts” can only be seen in the user group “Expert”.

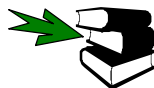

More detailed information about the handling of menus, inline forms and status windows can be found in the chapter **[The KUKA Control Panel KCP]**.

7.4.1 Oscilloscope

The function “Oscilloscope” is used to record motion data or the status of the controller’s inputs and outputs. These data are required for setup, optimization and troubleshooting, for instance.

Up to twenty channels, which can then be viewed and analyzed later, can be traced at the same time. An additional function allows two traces to be “superposed” on each other.

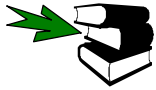

A detailed description of this function may be found in the **Electrical Servicing** handbook, in the main chapter **Diagnostic Functions**, chapter **[Oscilloscope]**.

7.4.2 Log book

Monitor

The submenu “Logbook” displays on the KCP certain logged operator actions carried out by the user. You can access this function by pressing the menu key “Monitor” and then selecting the submenu “Diagnosis” and activating the “Logbook” option contained within it.

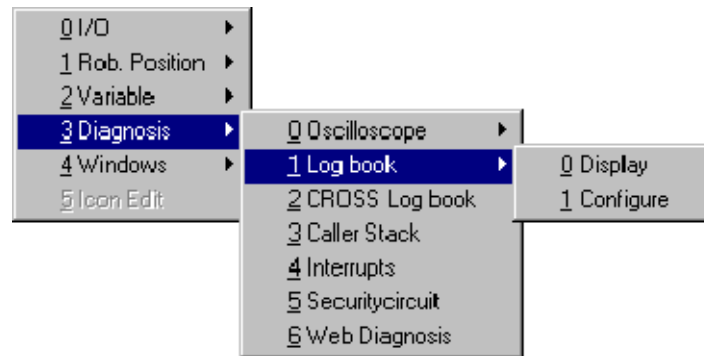

7.4.2.1 Display

Once this option has been selected, a status window is opened, in which information about the configuration, logbook list and filter types can be viewed and modified.

Info

The user can view the current configuration in the Info display.

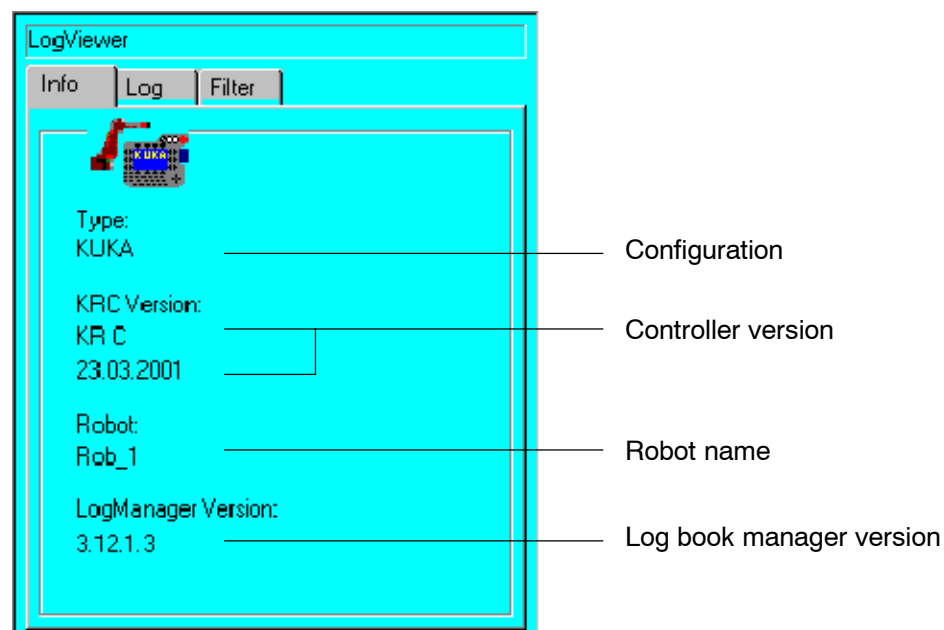

Tab +

The user can switch between the logbook, the filter and the information display by pressing the softkey "Tab +". The "TAB" key on the numeric keypad can be used for the same purpose. To do this, however, the "NUM" display in the status line must be deactivated.

Cancel

The logbook display can be terminated at any time using the softkey "Cancel".

Log

Selecting this option opens a status window displaying, on the KCP, the operator actions that have been carried out by the user and logged in a file.

The status window consists essentially of two main areas. The first area displays the type and number of the log event along with a brief description, while the second area contains more detailed information.

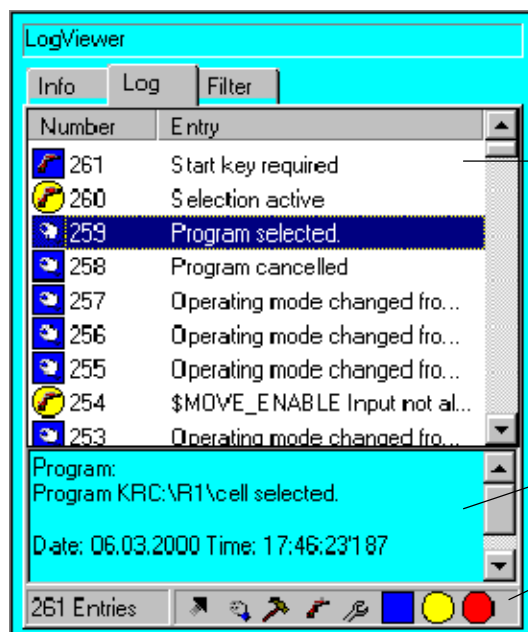

The screenshot shows the LogViewer window with three tabs: Info, Log, and Filter. The Log tab is active, displaying a list of log entries with columns for Number and Entry. The entry with number 259, "Program selected", is highlighted. Below the list, a detailed description is shown: "Program: Program KRC:NR1\cell selected." and "Date: 06.03.2000 Time: 17:46:23'187". At the bottom, there is a status bar showing "261 Entries" and several icons.

Area displaying type, number and description of the log event.

Area with detailed description of the log event

Area in which the selected filters are displayed.

















The log book can be evaluated online or offline. Software module debug information, process data and robot characteristic data such as motor currents, command values, etc. are not recorded.



If the text in the lower part of the status window is too big to fit in the display, you can scroll through the display line by line using the status key "Detail" or the keyboard shortcut "ALT" + "Cursor" ↓ or ↑.

The symbols in the log book display have the following meaning:

Icon	Shape/color	Content	Type of log entry
	round/yellow	Arm with hand	Warning during user operation
	octagonal/red		Error during user operation
	square/blue		Information during user operation
	round/yellow	Robot	Robot kernel system warning
	octagonal/red		Robot kernel system error
	square/blue		Robot kernel system information

	round/yellow	Arrow	Warning during boot procedure
	octagon/red		Error during boot procedure
	square/blue		Information during boot procedure
	round/yellow	Wrench	Warning during installation
	octagon/red		Error during installation
	square/blue		Information during installation
	round/yellow	Hammer	Program-generated warning
	octagon/red		Program-generated error
	square/blue		Program-generated information

Tab +

The user can switch between the logbook, the filter and the information display by pressing the softkey "Tab +". The "TAB" key on the numeric keypad can be used for the same purpose. To do this, however, the "NUM" display in the status line must be deactivated.

Export

The information in the logbook is saved in a text file. The path and name of this file can be set via "Log book" -> "Configure". The default setting here is "C:\KRC\Roboter\Log\Logbuch.txt".

Page +

The softkey "Page +" displays the next page up. Alternatively, the "PGDN" key on the numeric keypad can also be used.

Page -

The softkey "Page -" displays the next page down. The "PGUP" key on the numeric keypad can also be used here.

Refresh

The softkey "Refresh" updates the status window with the current data. This option is very useful if other actions have been carried out in the meantime.

Cancel

The log book display can be terminated at any time using the softkey "Cancel".

Filter

Using this status window, the user can select the filter types and classes to be listed in the logbook.

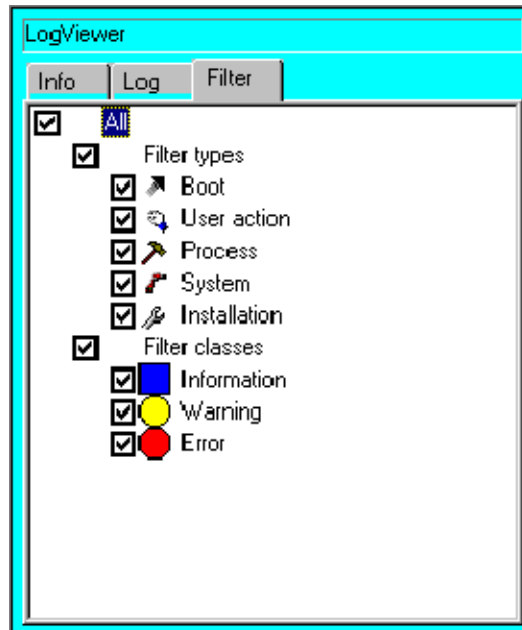

Tab +

The user can switch between the logbook, the filter and the information display by pressing the softkey "Tab +". The "TAB" key on the numeric keypad can be used for the same purpose. To do this, however, the "NUM" display in the status line must be deactivated.

Mark

The softkey "Mark" can be used to confirm the filter type or class selected using the arrow keys. This causes a check mark to appear or disappear in the corresponding box.

Apply

After completing your selection, press the softkey "Apply".

Cancel

The log book display can be terminated at any time using the softkey "Cancel".



At least one filter type and one filter class must be selected, otherwise a corresponding error message will appear when "Apply" is pressed.

7.4.2.2 Configuration

After this option has been selected a status window is opened for configuring the logbook.

The maximum number of logbook entries is defined in the upper box of the window. You can move to the lower box "Print / Output to file" by using the arrow keys. You can now use the space-bar to select or deselect "Apply filter". The path and the name of the desired logbook file can be specified in the box "Filename".



The softkey "OK" saves all changes and closes the configuration window.



The status window can be closed at any time by means of the softkey "Cancel".

7.4.3 CROSS Log book

This function displays the trace program “KUKA–Cross” that runs in the background.

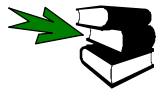
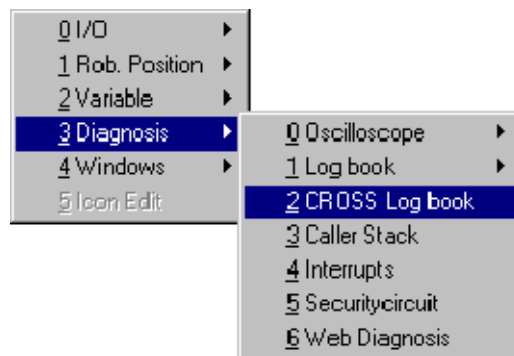

A detailed description of this function may be found in the **Electrical Servicing** handbook, in the main chapter **[Diagnostic Functions]**.

7.4.4 Caller Stack

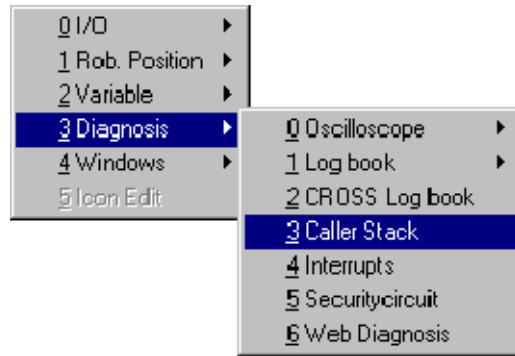

This menu item is not available below the user group "Expert".

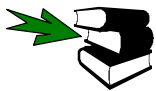

How to change user group is described in the **Programming Handbook**, in the documentation **[Configuring the system]**, chapter **[The "Configure" menu]**, section **"User group"**.

This function evaluates the data for the process pointer (`$PRO_IP`) and displays them as text. After this option has been selected, a status window is opened.

The following items are listed individually:

Call	Call number
Interrupt	If the call is caused by an interrupt
called from	Module name
SNo.	Line number of the jump
Sourceline	Line contents

Callerstack()				
Call	Int...	called from	S...	Sourceli...
1	None	cell.src	31	PO0 (#I...
2	None	p00.src	10	INIT_E...
3	None	p00.src	61	PO0_M...

called from KRC:\R1\cell.src
 Sourceline PO0 (#INIT_EXT,#PGNO_GET,DMY[]),0
 Initialize extern mode

A summary of the information from above is displayed in the lower line.

Operator Control

jump to

The softkey "jump to" can be used to open the selected call and display the corresponding line with a gray background.

Refresh

"Refresh" updates the caller stack.

Close

The softkey "Close" terminates the function and closes the status window.

7.4.5 Interrupts

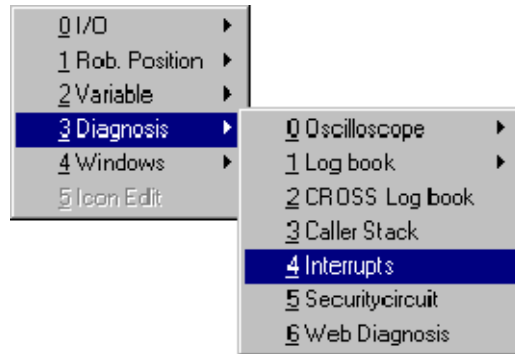

This menu item is not available below the user group “Expert”.

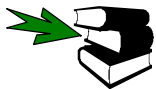

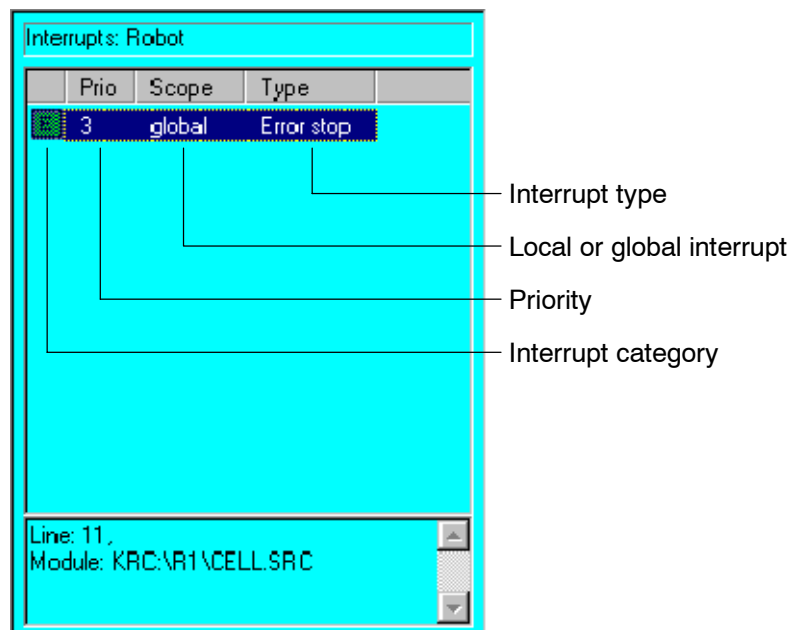

How to change user group is described in the **Programming Handbook**, in the documentation **[Configuring the system]**, chapter **[The “Configure” menu]**, section **“User group”**.

When the menu item “Interrupts” is selected, a status window opens showing a list of declared “robot” interrupts. Information is provided about priority (from 1 to 128), scope (global, local), type (standard, stop, measure, error stop and trigger), module name with path specification and the line number of the individual interrupt.



The interrupts are shown as symbols, which are explained in the table below:

Icon	Shape/color/contents	Nature of interrupt
	Square / gray / -	Inactive interrupt
	Square / red / D	Active, disabled interrupt
	Square / green / E	Active, ON interrupt

Submit

You can obtain information about the Submit interrupts with the aid of the softkey “Submit”. They are listed in the same way as the “Robot” interrupts. This softkey changes back and forth between Submit and Robot.

Refresh

Pressing this softkey updates the display.

Close

To exit this menu, press the softkey “Close”.



Further information on the topic “Interrupts” may be found in the **Programming Handbook**, in the documentation **[Expert Programming]**, chapter **[Interrupt handling]**.

7.4.6 Safety circuit

This external program allows diagnosis of the safety circuit of the robot in question.

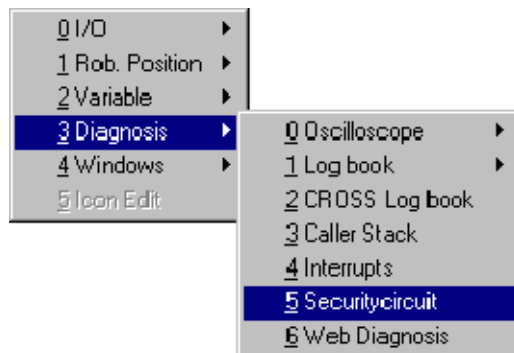

A description of the “Securitycircuit” function may be found in the **Electrical Servicing handbook**, in the main chapter **[Diagnostic Functions]** chapter **[Safety circuit]**.

7.4.7 Web Diagnosis

This function is used for remote diagnosis.

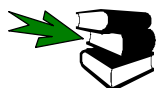

Further information about the Web Diagnosis function can be found in the **Administrator handbook**.

7.5 Windows

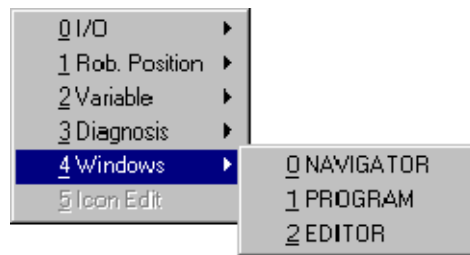

When Navigator, Program or Editor is selected, the corresponding window will be brought to the foreground. If no program is selected, or nothing is present in the editor, these items will be shown as inactive in the upper menu.

7.6 Help



The “Help” menu offers the options “Online help”, “Online Help – Contents/Index” and “Info”.

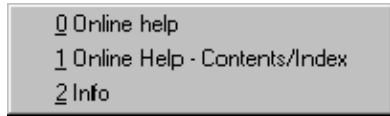

The window selection key will not work as long as the online help function is displayed.



If an external keyboard is connected, you can also call the online help function by pressing function key “F1”.

7.6.1 Online help

The online help function gives additional information about messages selected in the message window, the logbook display, the error display and inline forms. The element about which you require information must be selected.



If the message window in which the element is located is inactive, first you must switch to it using the window selection key. You can then highlight the desired message using the arrow keys.

7.6.1.1 Message window

Select the desired message using the arrow keys.



Ti...	no.	Source	Message
14:22	8	UserMode	User group: Expert
14:23	1	/	EMERGENCY STOP

Then activate the online help function.

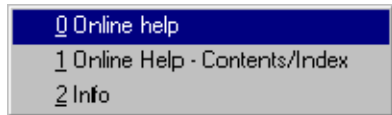

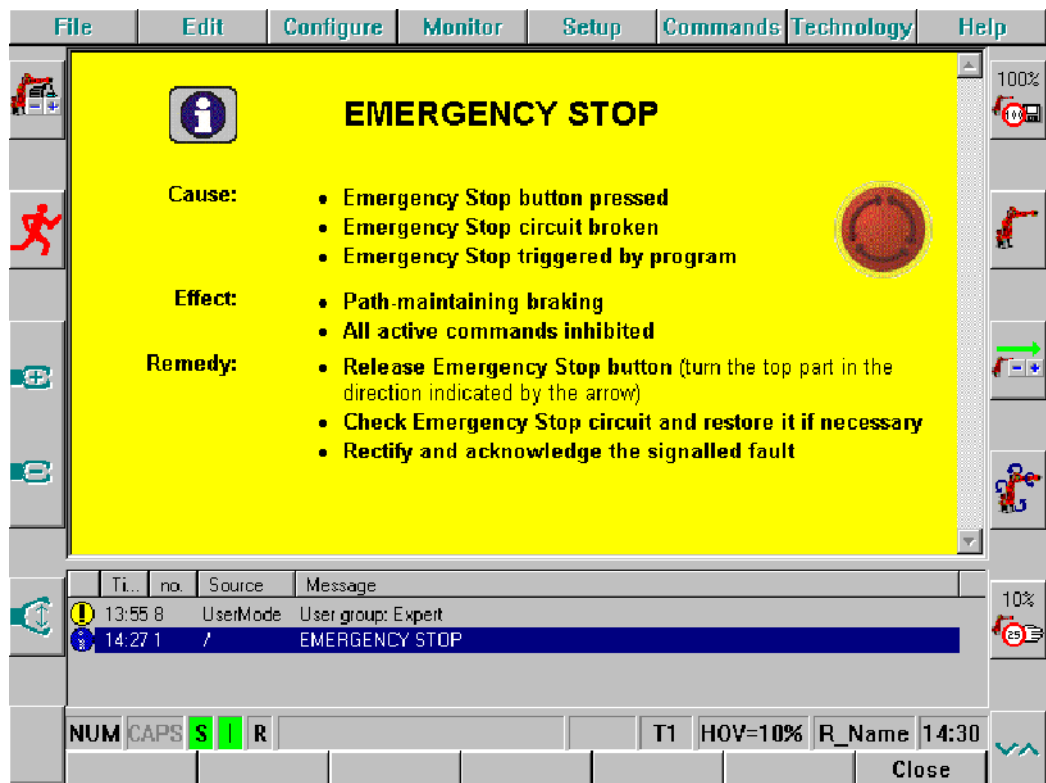

If the contents of the help window cannot all be displayed at one time, use the arrow keys to page through the contents.

Close

Use the softkey "Close" to exit the online help function and return to normal operation.

7.6.1.2 Log book

Select the desired message in the logbook using the arrow keys.



Then activate the online help function.

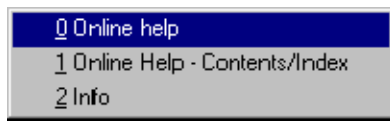

If the contents of the help window cannot all be displayed at one time, use the arrow keys to page through the contents.

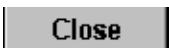

Use the softkey "Close" to exit the online help function and return to normal operation.

7.6.1.3 Inline forms

Open an inline form for which you require a more detailed description. This may be a new or existing motion command, for example.

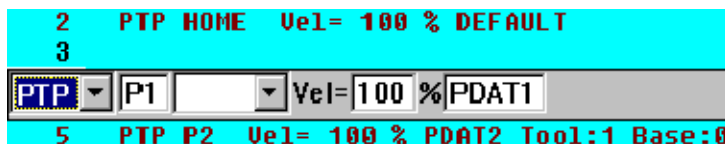

Then activate the online help function.

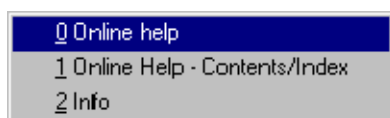

Programming a PTP motion

PTP is a **point-to-point** motion. The robot system is moved along the **quickest route** between two points. All axes start to move simultaneously and stop simultaneously (synchronous motion).

The PTP motion follows a path defined by the robot which **cannot be predicted exactly!** In order to avoid possible collisions, this path must first be executed at reduced program override (POV) near obstacles!

Close

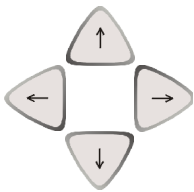

If the contents of the help window cannot all be displayed at one time, use the arrow keys to page through the contents.

Close

Use the softkey "Close" to exit the online help function and return to normal operation.

7.6.1.4 Error display

Use the arrow keys to select the line containing the error in question.

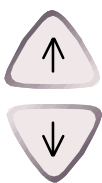

Line	Col.	Error ...	Description
4	35	2161	'DO' expected
6	6	2139	Specified type is...
9	9	2241	Right operand n...
11	19	2347	Value for PRIO i...
17	50	2138	Name invalid for...
18	14	2319	'ON','OFF','ENA...
32	38	2135	Name not decla...

***[INTERRUPT DECL 3\WHEN
\$STOPMESS=555=TRUE DO IR_STOPM ()
'DO' expected

Then activate the online help function.

Online help

1 Online Help - Contents/Index

2 Info

File	Edit	Configure	Monitor	Setup	Commands	Technology	Help
------	------	-----------	---------	-------	----------	------------	------

!" "DO" expected

Cause: The keyword "DO" has been omitted in an INTERRUPT or TRIGGER instruction.

Syntax:
 INTERRUPT DECL *Priority*
 WHEN *Condition* DO
Subprogram name
 TRIGGER WHEN DISTANCE = *Switching point* DELAY = *Time* DO *Instruction* PRIO = *Priority*

Effect: The program cannot be executed.

Line	Col.	Error ...	Description
4	35	2161	'DO' expected
6	6	2139	Specified type is...
9	9	2241	Right operand n...
11	19	2347	Value for PRIO L...
17	50	2138	Name invalid for...
18	14	2319	'ON','OFF','ENA...
32	38	2135	Name not decla...

```

            ...INTERRUPT DECL 3 WHEN
            $STOPMESS=555=TRUE DO IR_STOPM ()
            'DO' expected
        
```

Ti...	no.	Source	Message
!	13:43 1421	/R1/PROG_04 : 7	Compilation error
!	13:43 0	TPUSER	Initialization in progress
!	13:43 0	TPUSER	Initialization finished
!	13:43 40	BOF	PowerOn finished.

NUM CAPS S I R
T1 POV=100% R_Name 13:52
Close



If the contents of the help window cannot all be displayed at one time, use the arrow keys to page through the contents.

Close

Use the softkey "Close" to exit the online help function and return to normal operation.

7.6.2 Online Help – Contents/Index

Here you can make targeted searches for information in the table of contents or index of the online help function.

Online help

1 Online Help - Contents/Index

Info

After this option has been selected the corresponding window appears on the user interface.

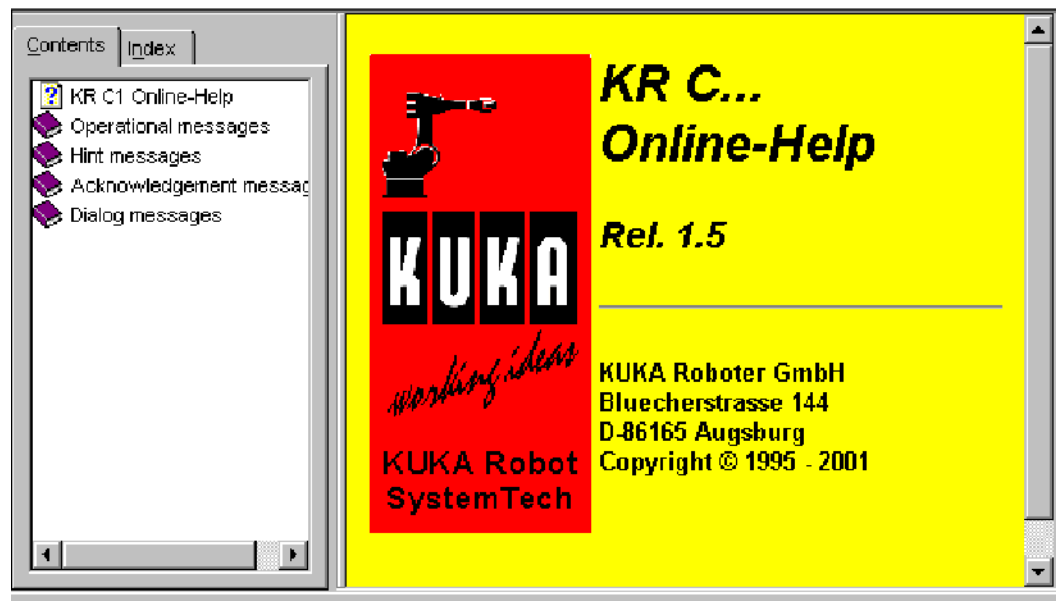

The left-hand side of the window shows a list of contents or the index, while the right-hand side displays the corresponding help messages. The following navigation options are available:



The arrow keys “↑” and “↓” can be used to select a subject, or to page through the help messages.



The arrow keys “→” and “←” or the Enter key can be used to open or close a subdirectory.

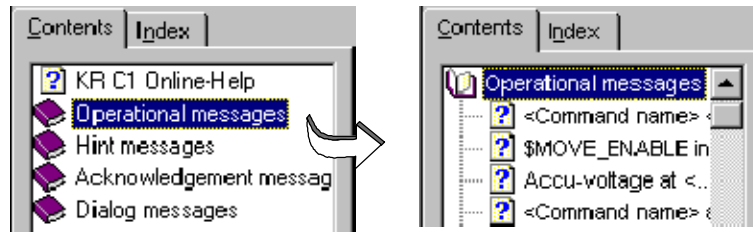

Once you have selected a subject, press the Enter key to display the corresponding help page.

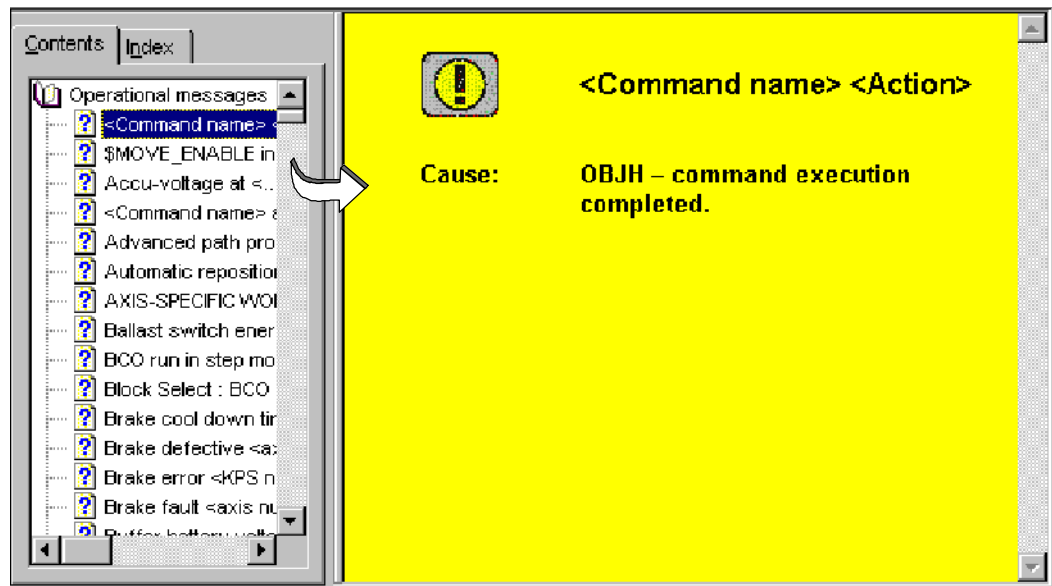

Use this softkey to switch between Contents/Index and the corresponding help page. You can then use the arrow keys to page through the subjects and/or help messages. If the focus is on the left-hand side of the page, the Contents/Index is active; otherwise the help page is active.

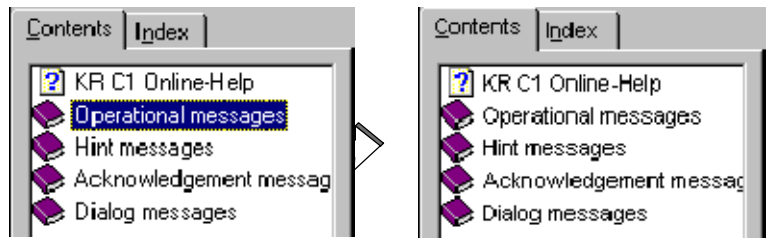

Contents/Index active

Help page active



Pressing the softkey "Index" brings you to the overall index of the online help function. Typing one or more letters in the input line will cause the list to be scrolled forward immediately to the appropriate location.

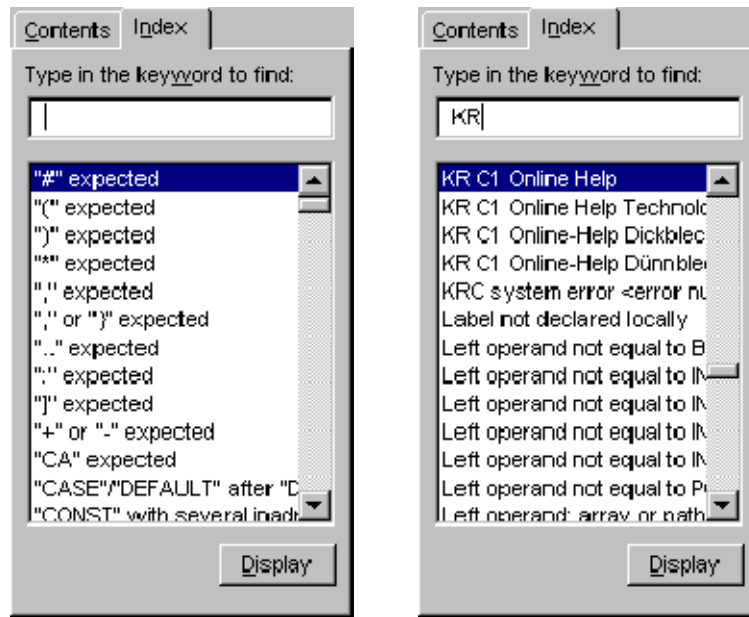

To avoid having to type in the entire term, you can use the arrow keys to scroll the focus up or down a line at a time.



Once you have found the desired term, press the Enter key or the “Display” button. The help page will then appear on the right-hand side of the display.

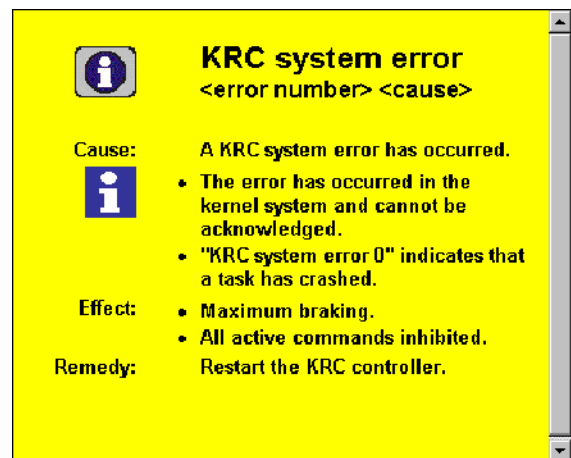
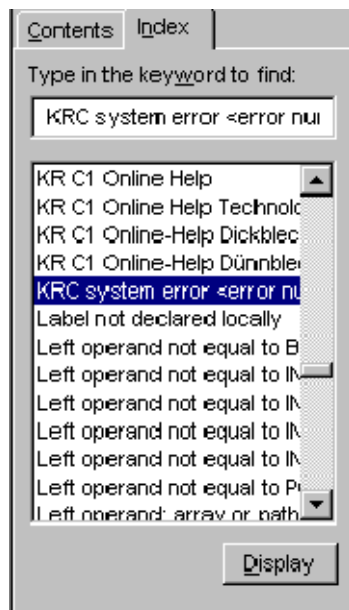

Contents

Pressing the softkey “Contents” takes you to the table of contents which is displayed by default when the online help function is started.

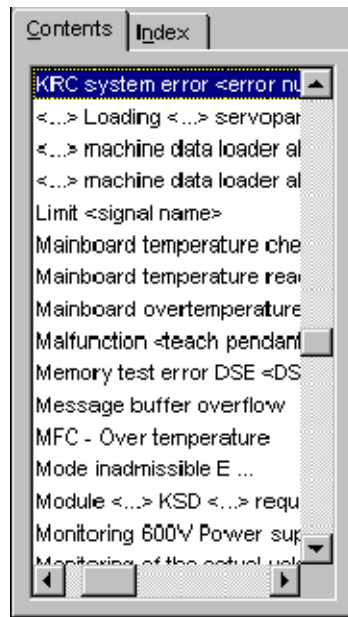

Close

Press the softkey "Close" to end the online help function and return to normal operation.

7.6.3 Info

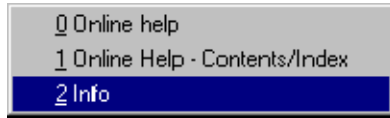

This command displays the following version information:

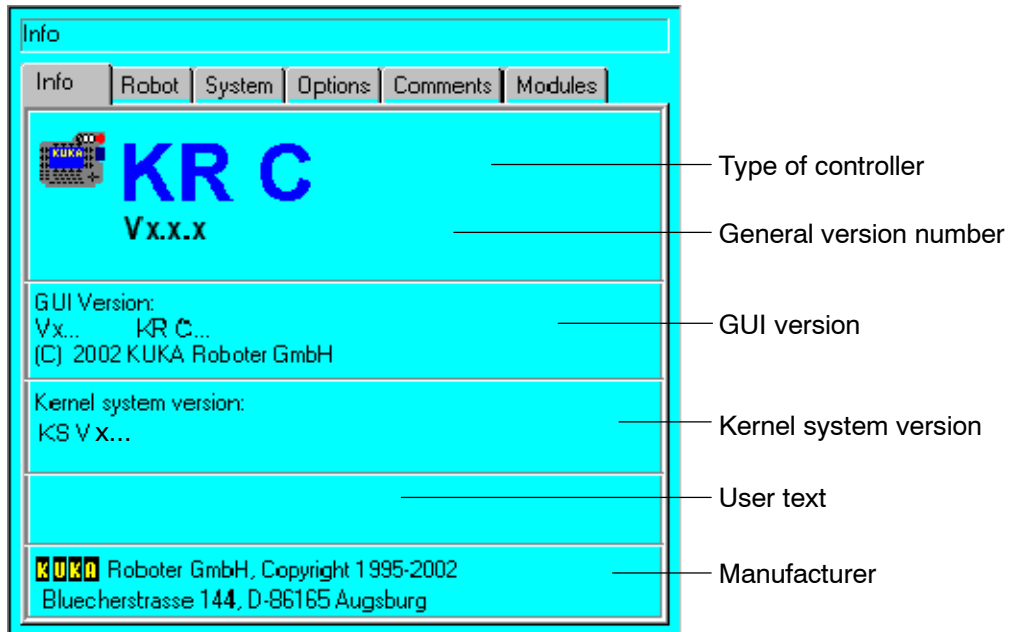

Tab +

The softkey "Tab+" takes you to the next page in which information about the robot is displayed.

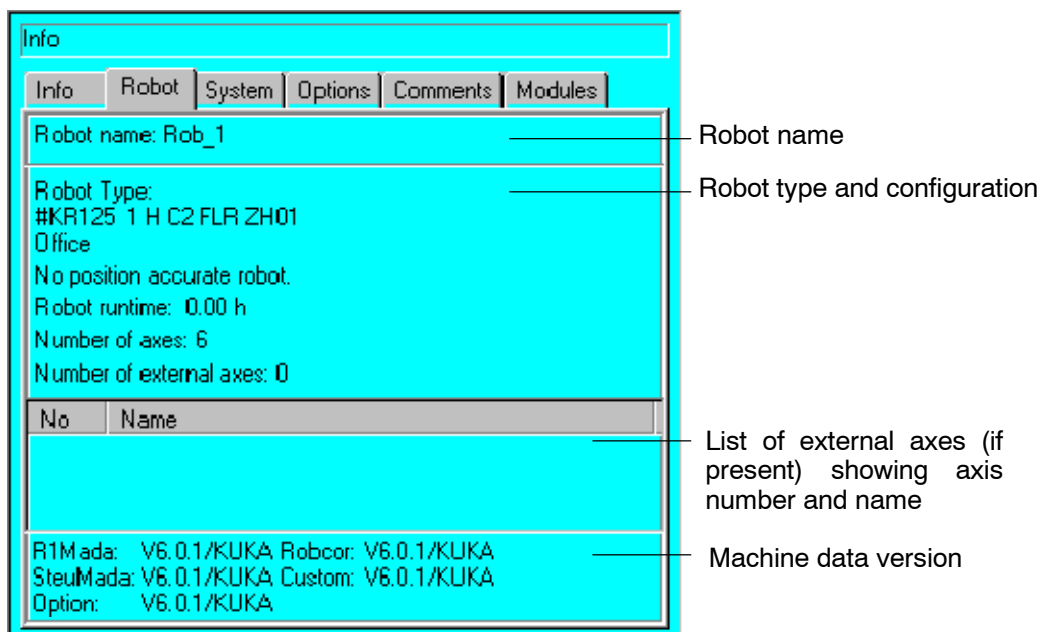

Tab + The next page contains information about the system.

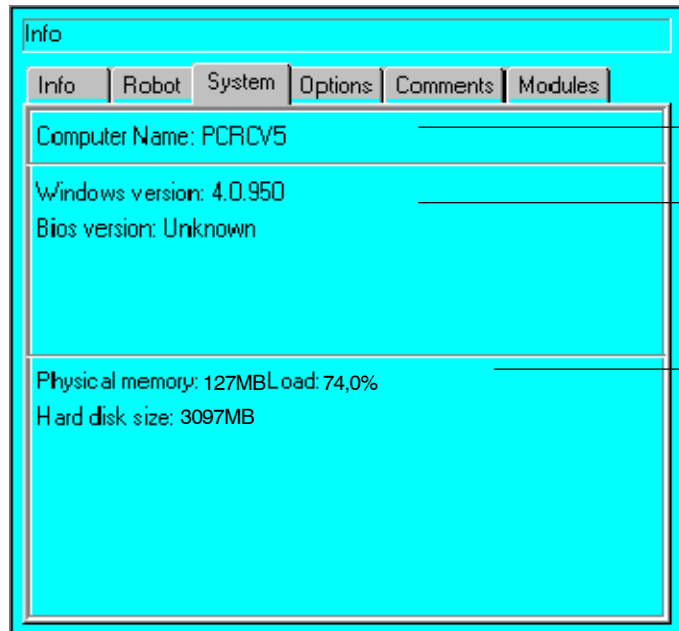

The screenshot shows a menu with tabs: Info, Robot, System, Options, Comments, and Modules. The 'Info' tab is selected, displaying the following data:

- Computer Name: PCRCV5
- Windows version: 4.0.950
- Bios version: Unknown
- Physical memory: 127MB Load: 74,0%
- Hard disk size: 3097MB

Labels on the right side of the image point to these specific data points:

- Computer name
- System version information
- Memory information

Tab + Pressing the softkey again opens the next available page in which additionally installed options, such as “MeasureTech” and “LaserCut” are listed.

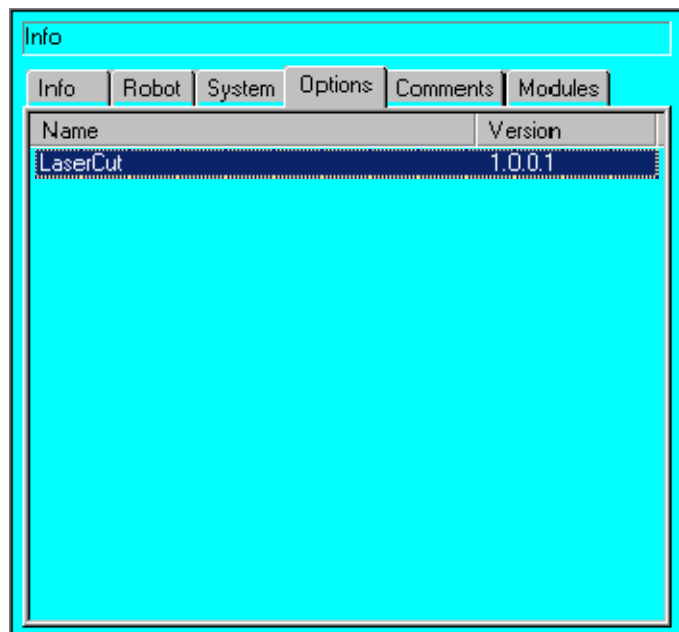

The screenshot shows the 'Options' tab selected in the 'Info' menu. It displays a table of installed options:

Name	Version
LaserCut	1.0.0.1

Tab + Additional comments can be found on the next page.

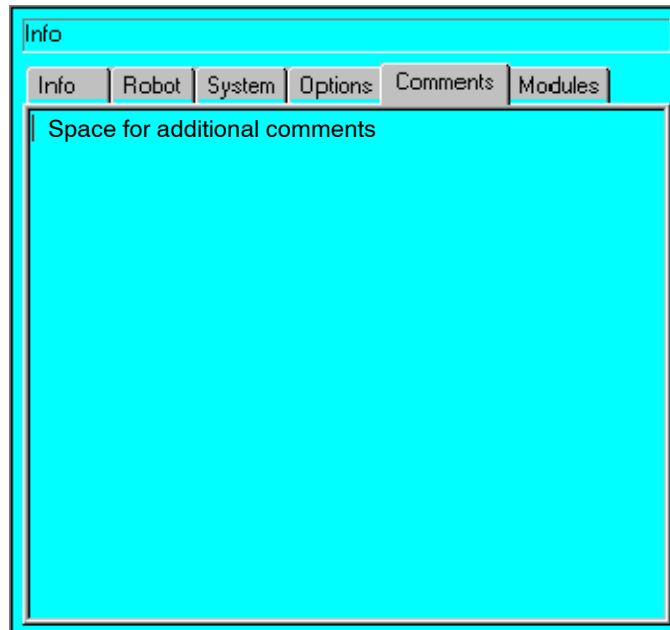

Tab + The next page contains information about the modules used.

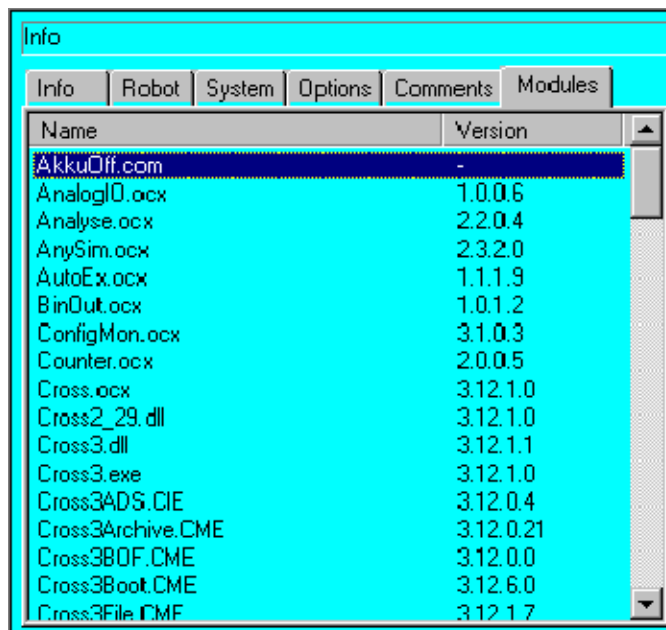

Versions of the modules present

Save

The softkey "Save" allows you to send the module information to a text file. This, by default, is the file "C:\KRC\Roboter\Log\ocxver.txt".

Tab +

The last page contains information about the virus scanner running in the background.

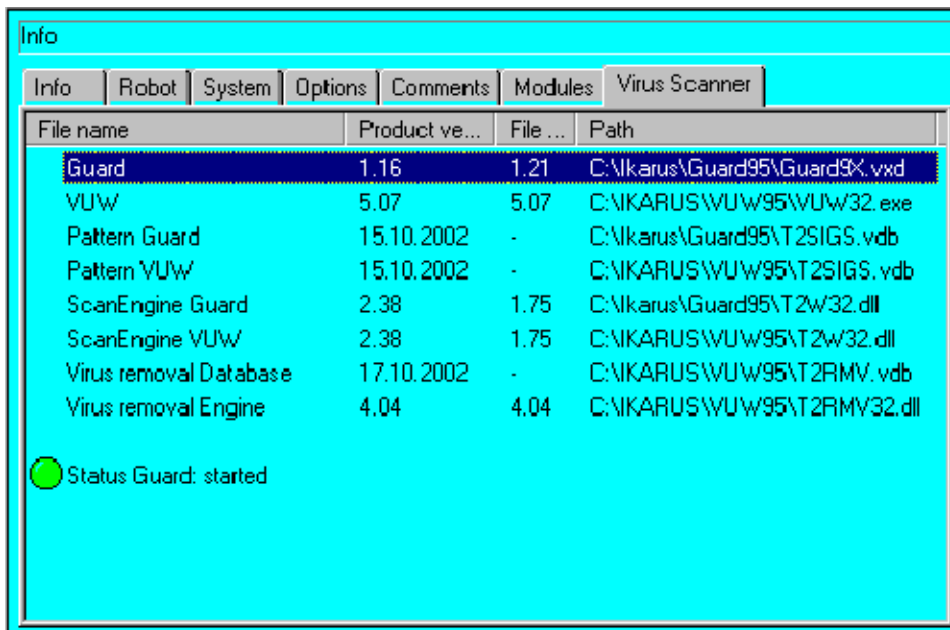

The screenshot shows a window titled 'Info' with several tabs: 'Info', 'Robot', 'System', 'Options', 'Comments', 'Modules', and 'Virus Scanner'. The 'Virus Scanner' tab is active, displaying a table with the following data:

File name	Product ve...	File ...	Path
Guard	1.16	1.21	C:\kikus\Guard95\Guard95.vxd
VUW	5.07	5.07	C:\KARUS\WUW95\WUW32.exe
Pattern Guard	15.10.2002	-	C:\kikus\Guard95\T2SIGS.vdb
Pattern VUW	15.10.2002	-	C:\KARUS\WUW95\T2SIGS.vdb
ScanEngine Guard	2.38	1.75	C:\kikus\Guard95\T2W32.dll
ScanEngine VUW	2.38	1.75	C:\KARUS\WUW95\T2W32.dll
Virus removal Database	17.10.2002	-	C:\KARUS\WUW95\T2RMV.vdb
Virus removal Engine	4.04	4.04	C:\KARUS\WUW95\T2RMV32.dll

Below the table, there is a green circle icon followed by the text: Status Guard: started

Export

The softkey "Export" allows you to send information about the virus scanner to the file "C:\KRC\Roboter\Log\VirusInfo.xml".

Close

The version display is closed using the softkey "Close".



Should you encounter any difficulties with your robot system, please quote the relevant version numbers when making inquiries.

8 Menu structure

8.1 General

The menus provided by the “KUKA System Software” can be opened by pressing the corresponding menu key.

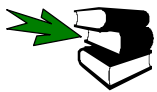
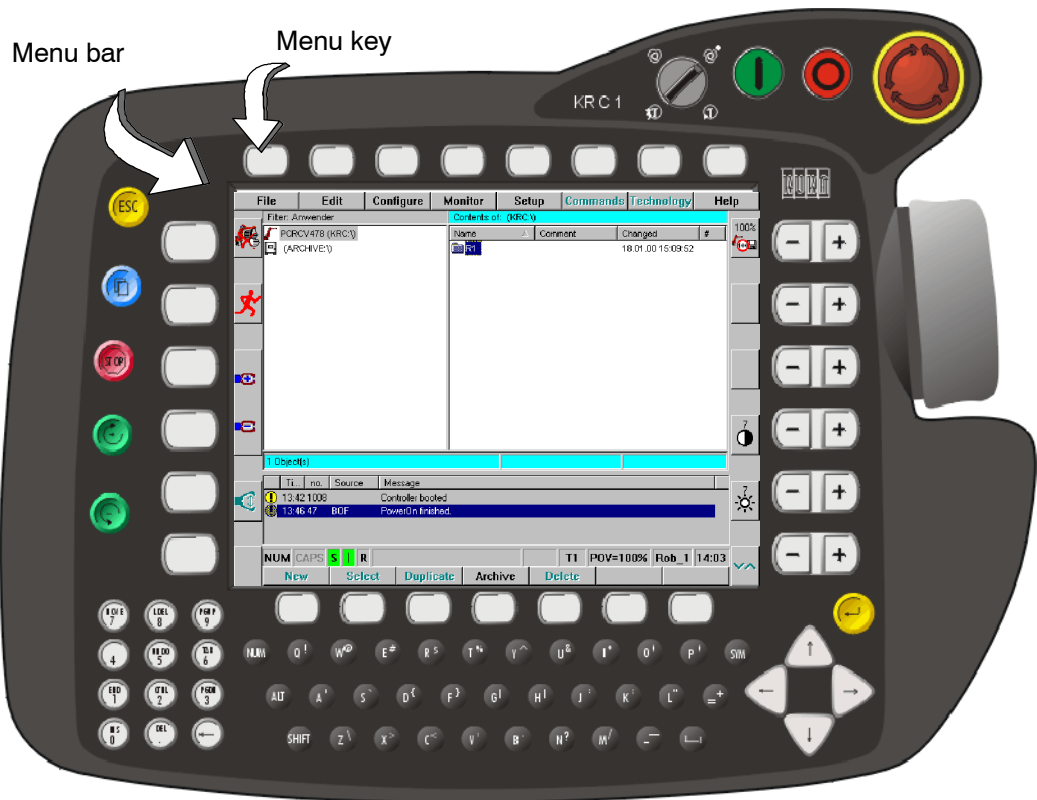

For further information about operator control please refer to the chapter **[The KUKA Control Panel KCP]**.

The following commands are available to you via the KUKA software menu bar:

File	Program	Configure	Monitor	Setup	Commands	Technology	Help
------	---------	-----------	---------	-------	----------	------------	------

Depending on whether the Navigator, Programming, or Editor level is being used, the menu keys “Setup”, “Commands” and “Technology” will be activated or deactivated.

You can open the menus shown below by pressing the corresponding menu key and select the desired function from the submenu which then opens.

Menu key	Options	Section
File	File operations and display	8.2
Program	Commands relating to program creation and editing	8.3
Configure	Inputs/outputs, drivers and other system settings	8.4
Monitor	Monitor functions for inputs/outputs, position, counters, variables and diagnosis	8.5
Setup ¹⁾	Mastering, calibration and service functions	8.6
Commands ²⁾	Motion and logic commands, KRL Assistant	8.7
Technology	Technology commands ARC Tech, SPOT Tech, GRIPPER Tech, TOUCH Sense, USER	8.8
Help	Version information and online help	8.9
¹⁾ No program may have been selected or loaded into the editor ²⁾ This function is only available within a program		



Whether or not specific submenus and commands can be accessed depends on the user group that is being used.

8.2 File



User group "Expert"

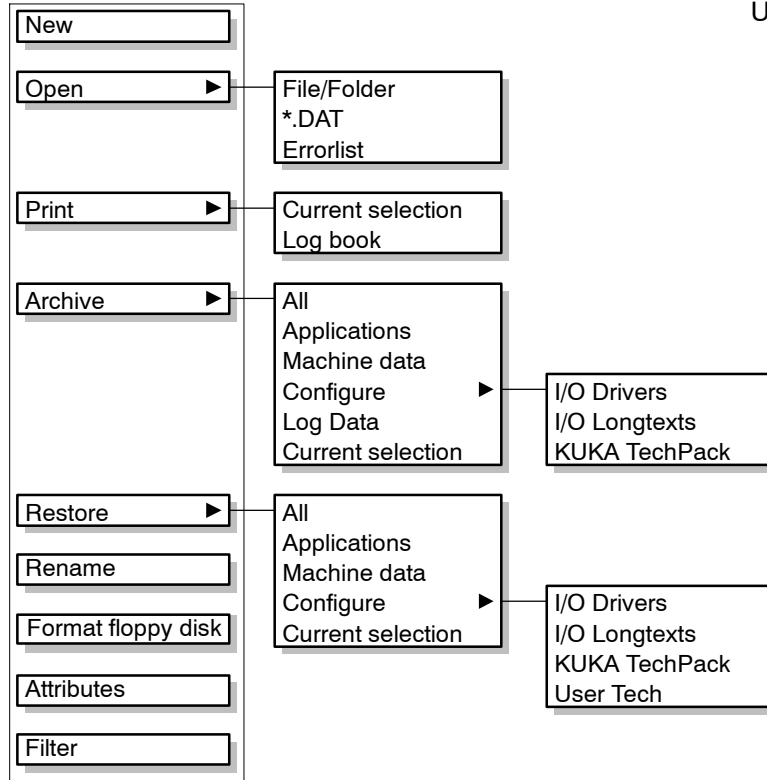

User group "User"

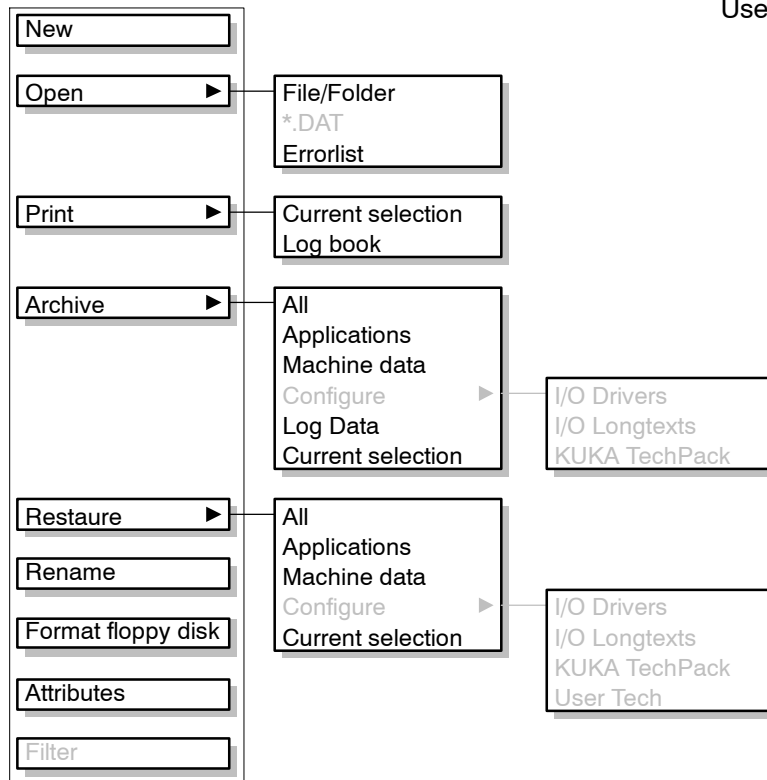



New

New	
Creation of new files and subdirectories ¹⁾	MC [Operator Control], Ch. [Navigator]
¹⁾ Not available in the user group "User".	

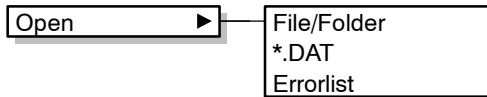

Open	
» File/Folder Opens the selected folder Loads the source file of a selected module (*.SRC) into the editor	MC [Operator Control], Ch. [Navigator]
» *.DAT Opens the data list (*.DAT) of a selected file in the editor	
» Errorlist Opens a list of errors that have been detected in the selected file	

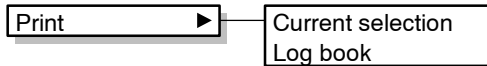

Print	
» Current selection The selected files are printed	MC [Operator Control], Ch. [Navigator]
» Log book The logbook entries are printed	

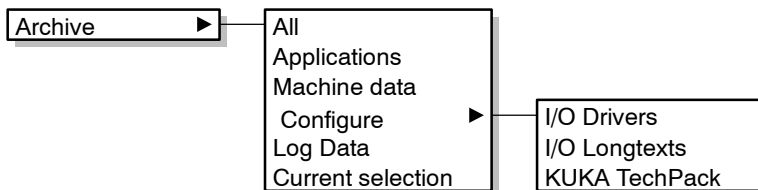

Archive	
» All All files are saved to floppy (Ini, MaDa, etc.)	MC [Operator Control], Ch. [Navigator]
» Applications Saves the applications (*.SRC, *.DAT) to floppy	
» Machine data Only saves the machine data to floppy	

» Configure ¹⁾ » I/O Drivers Saves the I/O drivers to floppy » I/O Longtexts Saves the long text database » KUKA TechPack Saves certain registry entries to floppy	MC [Operator Control], Ch. [Navigator]
» Log Data Saves the logbook files to floppy disk	
» Current selection Saves selected files and directories to floppy	
¹⁾ Not available in the user group "User".	

4

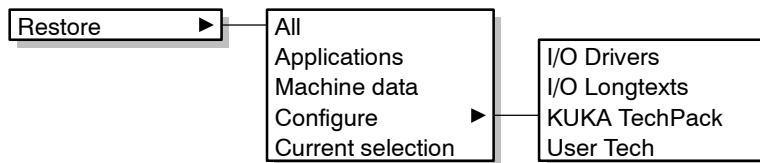

Restore	
» All All data, with the exception of log files, are loaded from the floppy disk (Ini, MaDa, etc.).	MC [Operator Control], Ch. [Navigator]
» Applications The saved applications are loaded back from the floppy disk onto the hard disk (*.SRC, *.DAT)	
» Machine data Only machine data are loaded from the floppy disk to the controller	
» Configure ¹⁾ » I/O Drivers Only the I/O drivers are loaded from the floppy disk » I/O Longtexts The I/O list is loaded from the floppy disk » KUKA TechPack Restores certain registry entries » User Tech UserTech-specific data are restored	
» Current selection Selected files are loaded back onto the hard disk	
¹⁾ Not available in the user group "User".	

UNDO
5

Rename

Rename	
The name of the selected file can be altered	MC [Operator Control], Ch. [Navigator]

TAB
6

Format floppy disk

Format floppy disk	
The floppy disk in the disk drive is formatted	MC [Operator Control], Ch. [Navigator]

HOME
7

Attributes

Attributes ²⁾	
Details about type, path, size, creation, attributes, edit mode and comment for the selected file	MC [Operator Control], Ch. [Navigator]
²⁾ Not available for program editing	

LDEL
8

Filter

Filter ^{1) 2)}	
Display variants for file components	MC [Operator Control], Ch. [Navigator]
¹⁾ Not available in the user group "User". ²⁾ Not available for program editing	

8.3 Program...

The “Program” menu appears differently at the Navigator, Programming and Editor levels.

8.3.1 “Program” in the navigator

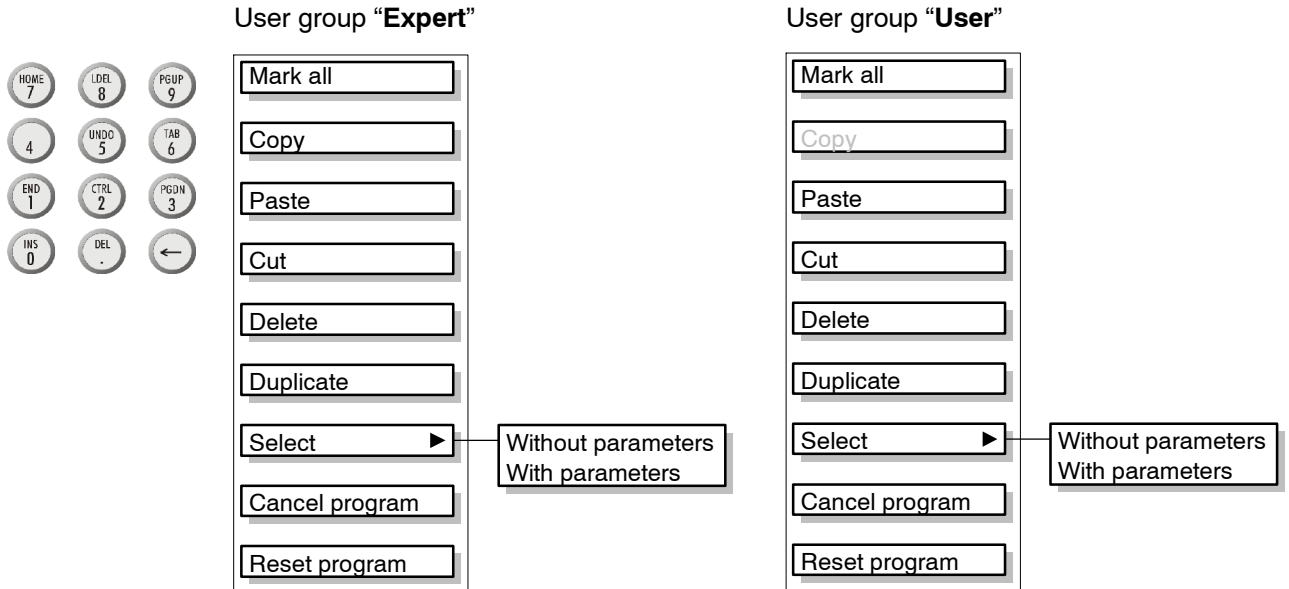

Mark all

Mark all	
All files in the selected folder are highlighted.	MC [Operator Control], Ch. [Navigator]



Copy

Copy ¹⁾	
Selected files are copied to the clipboard.	MC [Operator Control], Ch. [Navigator]
¹⁾ Not available in the user group “User”.	



Paste

Paste ³⁾	
Files from the clipboard are inserted at the current position	MC [Operator Control], Ch. [Navigator]
³⁾ Only available if a file has first been copied or cut	



Cut

Cut	
The selected files are deleted from their original position and copied to the clipboard	MC [Operator Control], Ch. [Navigator]



4

Delete

Delete	
All selected files are permanently deleted after a request for confirmation	MC [Operator Control], Ch. [Navigator]

UNDO
5

Duplicate

Duplicate	
The selected file is copied into the current folder under a different name	MC [Operator Control], Ch. [Navigator]

TAB
6

Select

Without parameters
With parameters

Select	
» Without parameters The program is selected without function parameters.	MC [Operator Control], Ch. [Navigator]
» With parameters The function parameters are transferred when the program is selected.	

HOME
7

Cancel program

Cancel program ²⁾	
The selected program is closed.	MC [Operator Control], Ch. [Navigator]
²⁾ Only available if a program has been selected	

LDEL
8

Reset program

Reset program ²⁾	
The initial state of the program after loading is restored.	MC [Operator Control], Ch. [Navigator]
²⁾ Only available if a program has been selected	

8.3.2 “Program” at programming level

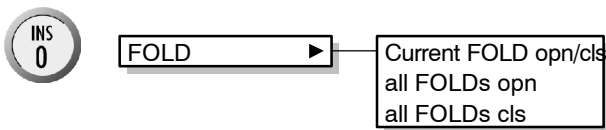
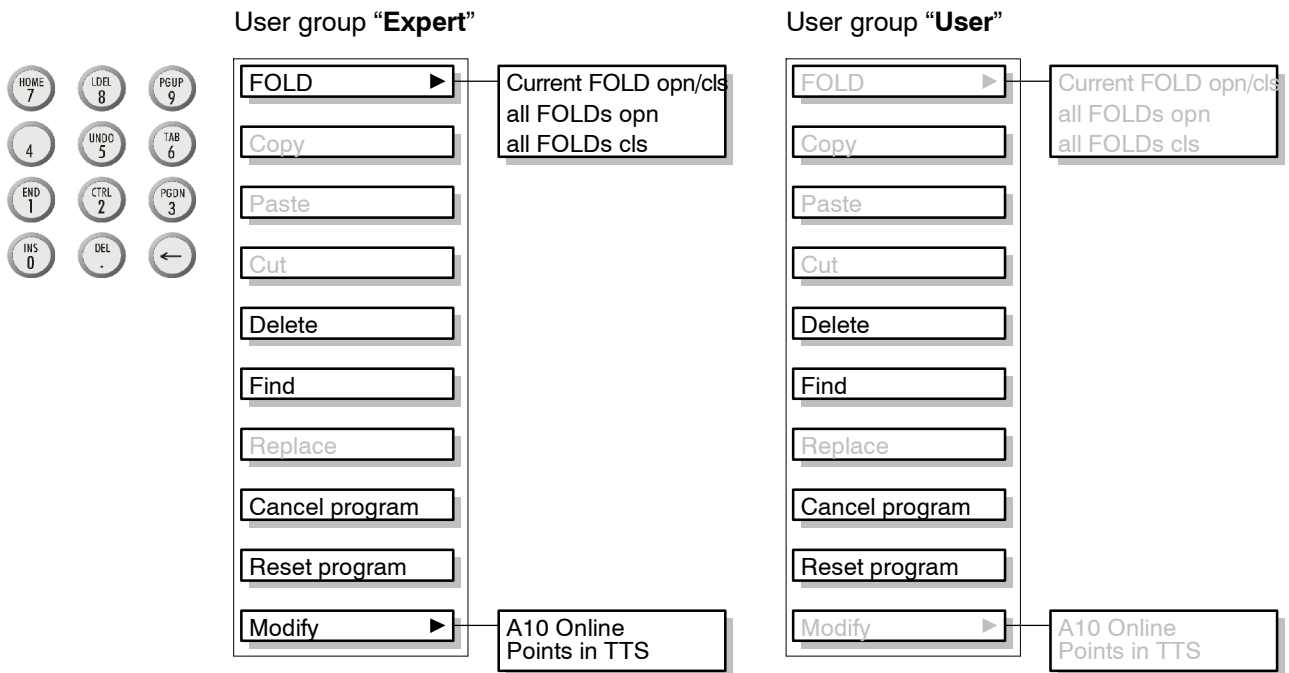

FOLD ¹⁾	
» Current FOLD opn/cls The fold in the current program line is opened or closed.	HB Progr. Handbook MC [Expert Progr.] Ch. [General informations on KRL programs]
» all FOLDs opn Opens all FOLDs in the selected program.	
» all FOLDs cls Closes all FOLDs in the selected program.	
¹⁾ Not available in the user group “User”.	

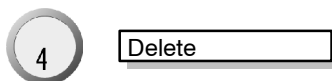

Delete	
After a request for confirmation, the line in which the edit cursor is situated is deleted.	MC [User Progr.] Ch. [Program editing]

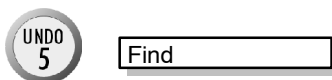

Find	
It is possible to search the current program for a search string.	MC [User Progr.] Ch. [Program editing]



Cancel program

Cancel program ³⁾	
The selected program is closed.	MC [User Progr.] Ch. [Program editing]
³⁾ Only available if a program has been selected	



Prog. zurücksetzen

Reset program ³⁾	
The initial state of the program after loading is restored.	MC [User Progr.] Ch. [Program editing]
³⁾ Only available if a program has been selected	



Modify ▶ A10 Online
Point in TTS

Modify ¹⁾	
» A10 Online ²⁾ Zusätzliche Option für die Technologie "ARC Tech 10"	HB ArcTech10
» Points in TTS Various online modification options for programs and motion commands.	MC Expert Programming Ch. [External editor]
¹⁾ Not available in the user group "User". ²⁾ Available if the technology package ArcTech10 has been loaded	

8.3.3 “Program” in the editor

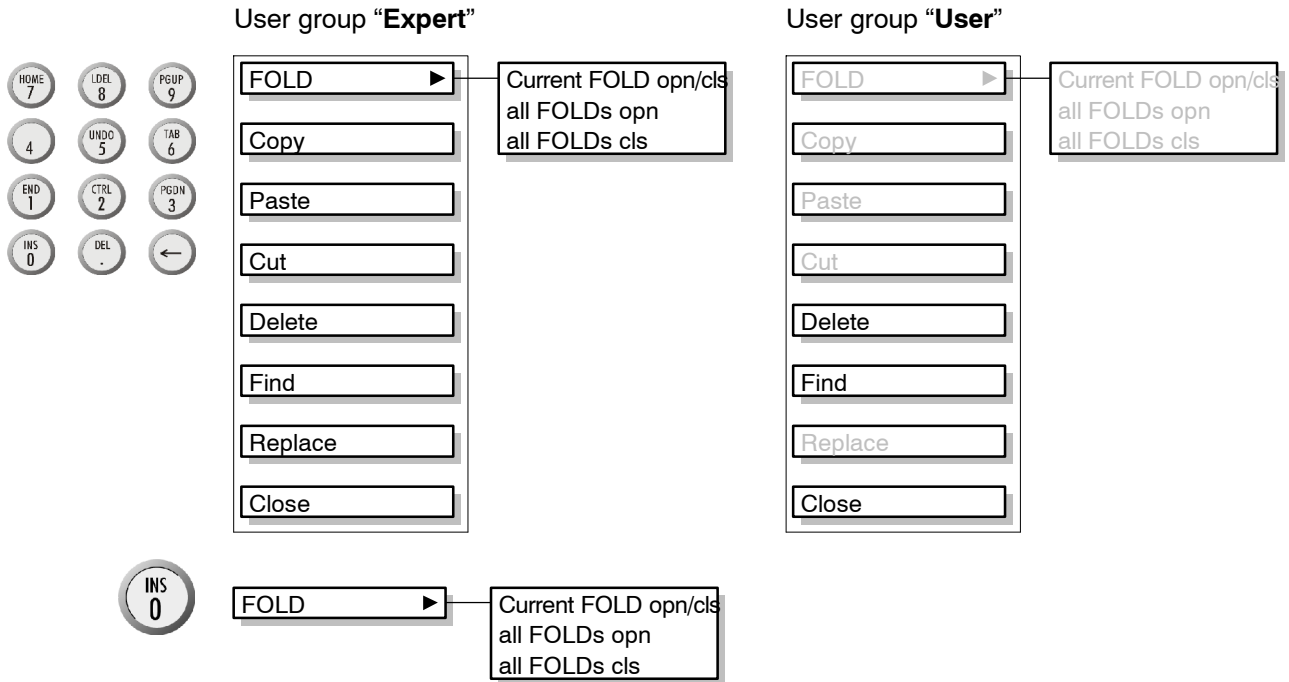

FOLD ¹⁾	
» Current FOLD opn/cls The fold in the current program line is opened or closed.	HB Progr. Handbook MC [Expert Progr.] Ch. [General information- s on KRL pro- grams]
» all FOLDs opn Opens all FOLDs of the program loaded in the editor.	
» all FOLDs cls Closes all FOLDs in the program loaded in the editor.	
¹⁾ Not available in the user group “User”.	

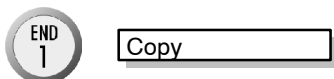

Copy ¹⁾	
The program line selected via the edit cursor is copied to the clipboard.	HB Progr. Handbook MC [Expert Progr.] Ch. [General information- s on KRL pro- grams]
¹⁾ Not available in the user group “User”.	

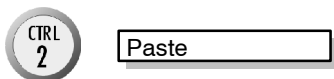

Paste ¹⁾	
Data from the clipboard are inserted at the current position.	HB Progr. Handbook MC [Expert Progr.] Ch. [General information- s on KRL pro- grams]
¹⁾ Not available in the user group “User”.	



PGDN
3

Cut

Cut ¹⁾	
The program lines selected by means of the edit cursor are deleted from their original position and copied to the clipboard.	HB Progr. Handbook MC [Expert Progr.] Ch. [General information on KRL programs]
¹⁾ Not available in the user group "User".	

4

Delete

Delete	
After a request for confirmation, the line in which the edit cursor is situated is deleted.	MC [User Progr.] Ch. [Program editing]

UNDO
5

Find

Find	
Search the current program for a specified search string	MC [User Progr.] Ch. [Program editing]

TAB
6

Replace

Replace ¹⁾	
Search and replace program sections in the editor.	HB Progr. Handbook MC [Expert Progr.] Ch. [General information on KRL programs]
¹⁾ Not available in the user group "User".	

HOME
7

Close

Close	
The editor is closed.	MC [User Progr.] Ch. [Program editing]

8.4 Configure

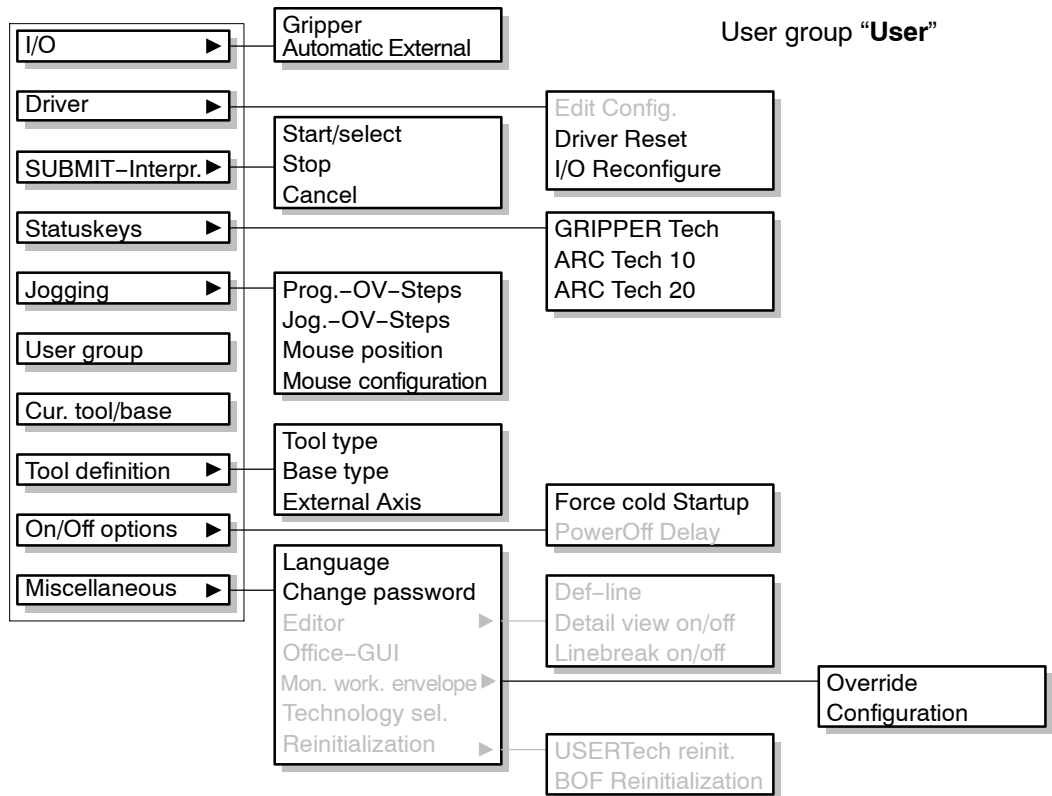
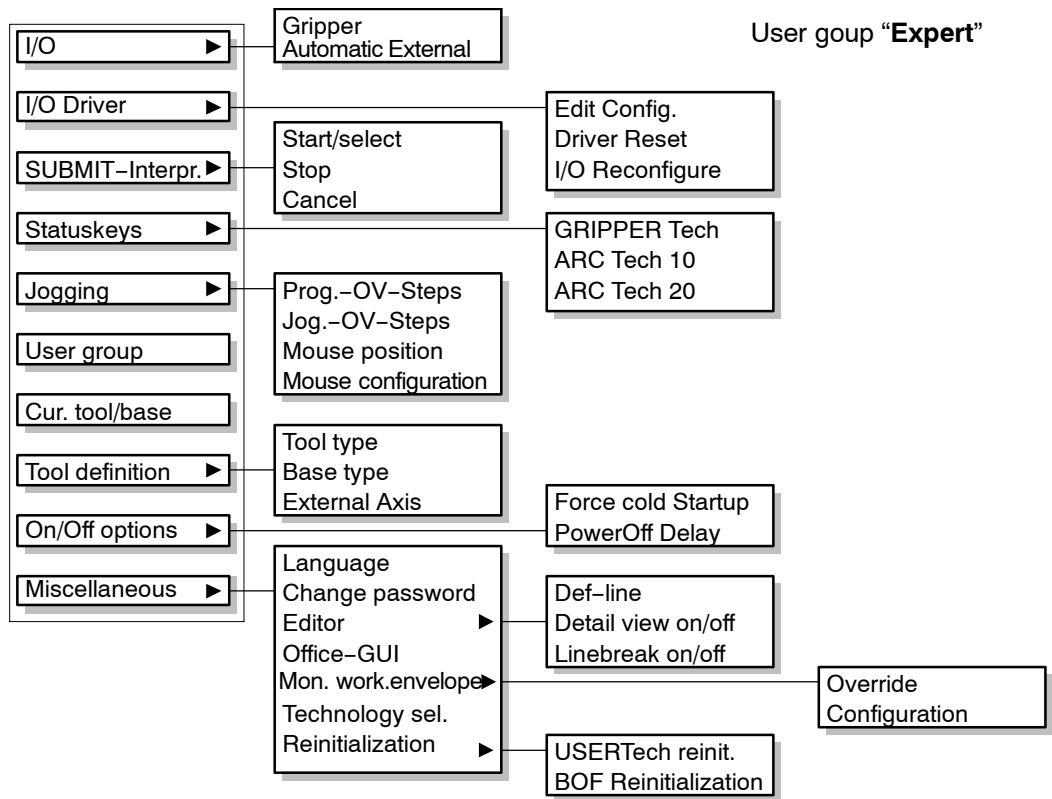

INS
0

I/O → Gripper
Automatic External

I/O	
» Gripper Gripper settings.	HB Progr. Handbook MC [Configuration] Ch. [Configuring the system]
» Automatic External Settings for the Automatic External interface.	

END
1

I/O Driver → Edit Config.
Driver Reset
I/O Reconfigure

I/O Driver	
» Edit Config. ¹⁾ Opens the file "IOSYS.INI".	HB Progr. Handbook MC [Configuration] Ch. [Configuring the system]
» Driver-Reset Resets the peripheral interfaces.	
» I/O Reconfigure The inputs/outputs are reconfigured.	
¹⁾ Not available in the user group "User".	

CTRL
2

SUBMIT-Interpr. → Start/Select
Stop
Cancel

SUBMIT Interpreter	
» Start/Select Start/select Submit interpreter.	HB Progr. Handbook MC [Configuration] Ch. [Configuring the system]
» Stop Stop Submit interpreter.	
» Cancel Deselect Submit interpreter.	

PGDN
3

Statuskeys → GRIPPER Tech
ARC Tech 10
ARC Tech 20

Statuskeys	
» GRIPPER Tech Status keys for optional technology package	HB Progr. Handbook MC [Configuration] Ch. [Configuring the system]
» ARC Tech 10 Status keys for optional technology package	
» ARC Tech 20 Status keys for optional technology package	

4

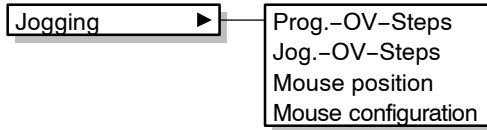

Jogging	
» Program-OV-Steps on/off Switches program override on/off.	HB Progr. Handbook MC [Configuration] Ch. [Configuring the system]
» Jog-OV-Steps on/off Switches manual (jog) override on/off.	
» Mouse position Definition of the spatial relationship between the 6D mouse and the robot.	
» Mouse configuration Axis selection and dominant mode.	

UNDO 5

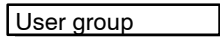

User group	
Access to certain user levels.	HB Progr. Handbook MC [Configuration] Ch. [Configuring the system]

TAB 6

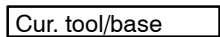

Cur. tool/base	
Selection of the desired tool, base system and/or kinematics.	HB Progr. Handbook MC [Configuration] Ch. [Configuring the system]

HOME 7

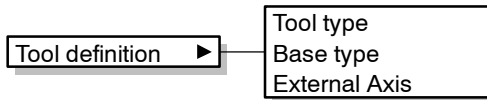

Tool definition	
» Tool type Display saved calibration data for the tool type.	HB Progr. Handbook MC [Configuration] Ch. [Configuring the system]
» Base type Display saved calibration data for the base type.	
» External Axis Display saved calibration data for external axes.	

LDEL
8

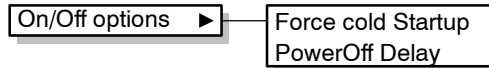

On/Off options	
» Force cold Startup The next time the controller is run-up, a complete restart without selection of any programs will be forced.	HB Progr. Handbook MC [Configuration] Ch. [Configuring the system]
» Disable PowerOff Delay ¹⁾ Delay before the system can be rebooted.	
1) Not available in the user group "User".	

PGUP
9

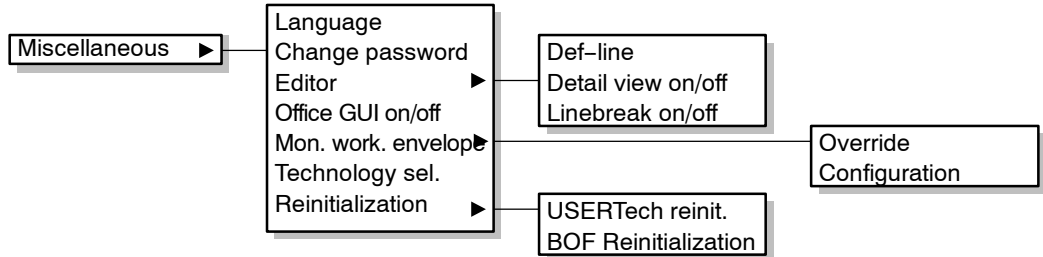

Miscellaneous	
» Language Changes the language used in the graphical user interface.	HB Progr. Handbook MC [Configuration] Ch. [Configuring the system]
» Change password Change the password for a user group.	
» Editor ¹⁾ <ul style="list-style-type: none"> » Def-line Displays the DEF lines in a program. » Detail view on/off The program is displayed in KRL code. » Linebreak on/off Activates/deactivates line breaks in the program window. 	
» Office GUI on/off ¹⁾ Additional operator control elements on the GUI for mouse operation.	
» Monitoring working envelope ¹⁾ <ul style="list-style-type: none"> » Override Overrides the monitoring of the work envelope. » Configuration Definition of the workspaces. 	
» Technology selection ²⁾ Selection of technologies (e.g. Kuka ARCTech, GRIPPER-Tech, ServoGun, ...) to be loaded.	

<p>» Reinitialization ¹⁾</p> <p>» USER Tech reinitialize USER Tech files are reinitialized without rebooting the system.</p> <p>» BOF reinitialization The GUI (Graphical User Interface) is reinitialized without rebooting the system.</p>	<p>HB Progr. Handbook MC [Configuration] Ch. [Configuring the system]</p>
<p>1) Not available in the user group "User". 2) Only available if a corresponding technology package has been installed.</p>	

8.5 Monitor

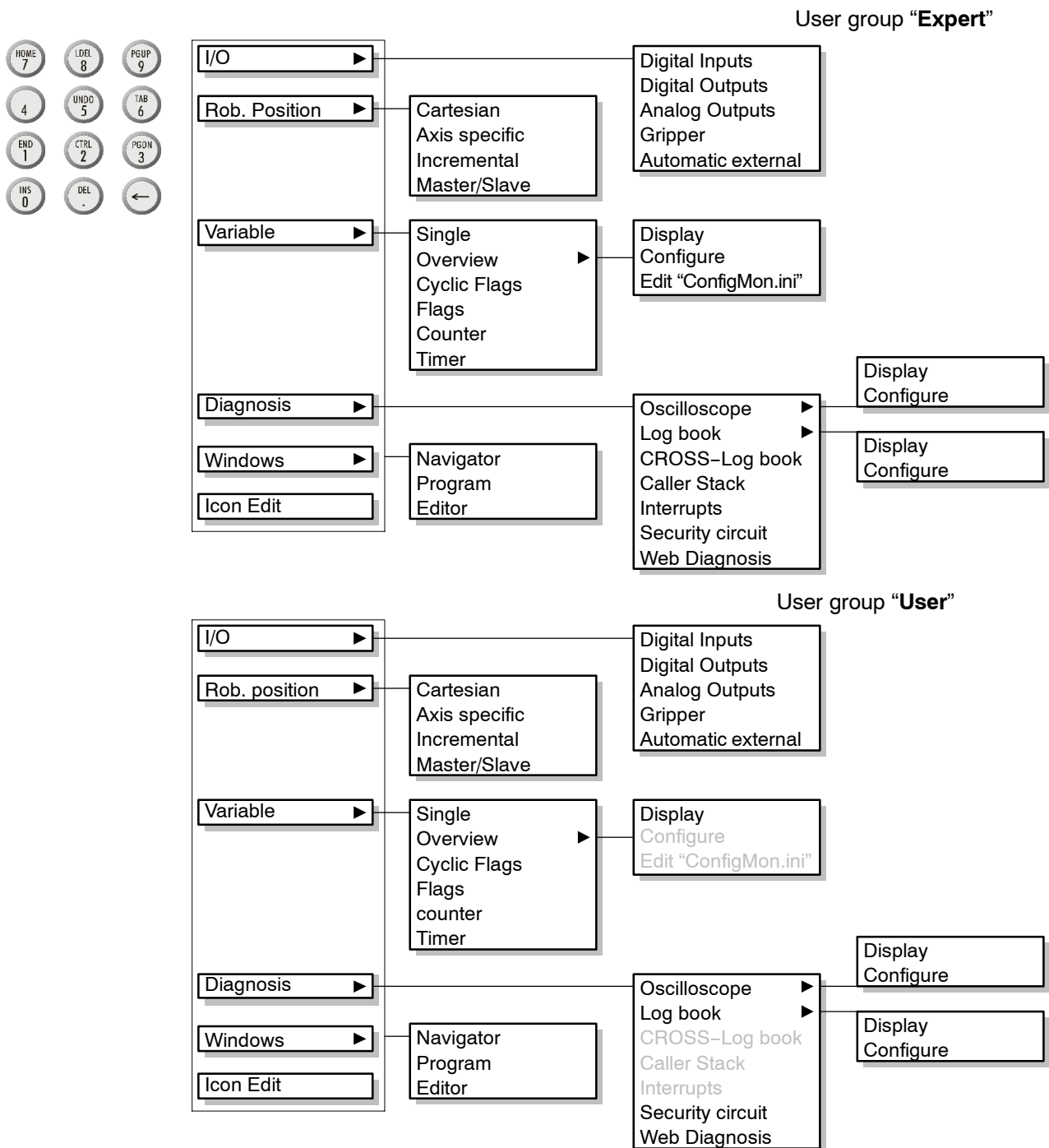

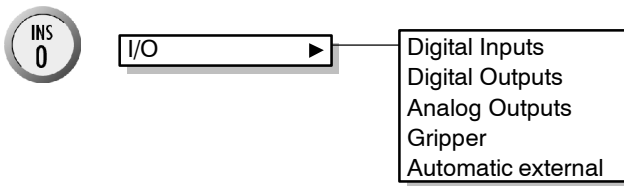

I/O	
» Digital Inputs Assignment of the digital inputs.	MC [Operator Control], Ch. [Monitor]
» Digital Outputs Assignment of the digital outputs.	
» Analog Outputs State of the analog outputs.	
» Gripper Assignment of the grippers.	
» Automatic external Assignment of the Automatic External interface.	MC [Operator Control], Ch. [Monitor]

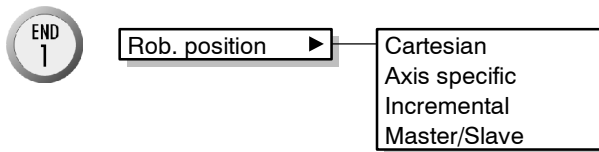

Rob. position	
» Cartesian Current position of the TCP with respect to the world coordinate system with the components "Position", "Orientation", "Status" and "Turn" of the standard axes and the configured external axes.	MC [Operator Control], Ch. [Monitor]
» Axis specific Current, axis-specific position of the standard axes and the configured external axes.	
» Incremental Current position of the robot axes in increments.	
» Master/Slave Current position of the master and slave axes in increments.	

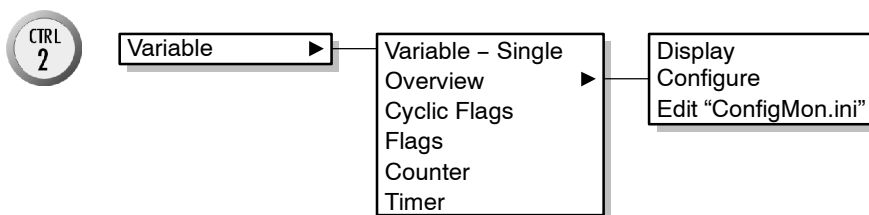

Variable	
» Single Display and modification of individual variable values.	MC [Operator Control], Ch. [Monitor]

<ul style="list-style-type: none"> » Overview » Display Displays the groups of variables in "ConfigMon.ini". » Configure ¹⁾ Settings for the variable group "Monitor". » Edit "ConfigMon.ini" ¹⁾ Editing of the file "ConfigMon.ini". 	<p>MC [Operator Control], Ch. [Monitor]</p> <p>HB Progr. Handbook MC [Configuring the system, Expert]</p>
<ul style="list-style-type: none"> » Cyclic Flags (Notice) Signal states for Notices (cyclical flags). 	<p>MC [Operator Control], Ch. [Monitor]</p>
<ul style="list-style-type: none"> » Flags Signal states of the flags. 	
<ul style="list-style-type: none"> » Counter Displays the values of the counters. 	
<ul style="list-style-type: none"> » Timer Values and operating states of the timers. 	
<p>¹⁾ Not available in the user group "User".</p>	

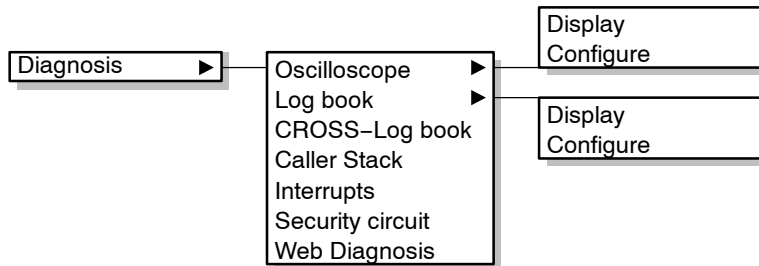

Diagnosis	
<ul style="list-style-type: none"> » Oscilloscope » Display View and analyze saved traces. » Configure Setting of the oscilloscope functions. 	<p>HB Electrical Servicing</p>
<ul style="list-style-type: none"> » Log book » Display Displays logged actions. » Configure Configuration of the logbook function. 	<p>MC [Operator Control], Ch. [Monitor]</p>
<ul style="list-style-type: none"> » Cross-Log book ¹⁾ Log program "Kuka-Cross". 	<p>HB Electrical Servicing</p>
<ul style="list-style-type: none"> » Caller Stack ¹⁾ Shows the sequence of program and subprogram calls. 	<p>MC [Operator Control], Ch. [Monitor]</p>
<ul style="list-style-type: none"> » Interrupts ¹⁾ Listing of interrupts. 	
<ul style="list-style-type: none"> » Security circuit Displays the safety circuit of the robot. 	<p>HB Electrical Servicing</p>
<ul style="list-style-type: none"> » Web Diagnosis Starts the internal Web browser which can be used to display predefined pages 	
<p>¹⁾ Not available in the user group "User".</p>	

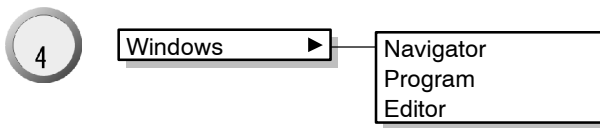

Windows	
<ul style="list-style-type: none"> » Navigator Displays the Navigator in the user interface. » Program ²⁾ Switches the user interface to the selected program. » Editor ³⁾ Displays the program that is loaded in the editor. 	MC [Operator Control], Ch. [Monitor]
<p>²⁾ Only available if a program has been selected. ³⁾ Only if there is a program in the editor.</p>	



Icon Edit ⁴⁾	
Additional module for icon-based programming.	Optional program package
⁴⁾ Optionally available	

8.6 Setup

User group "Expert"

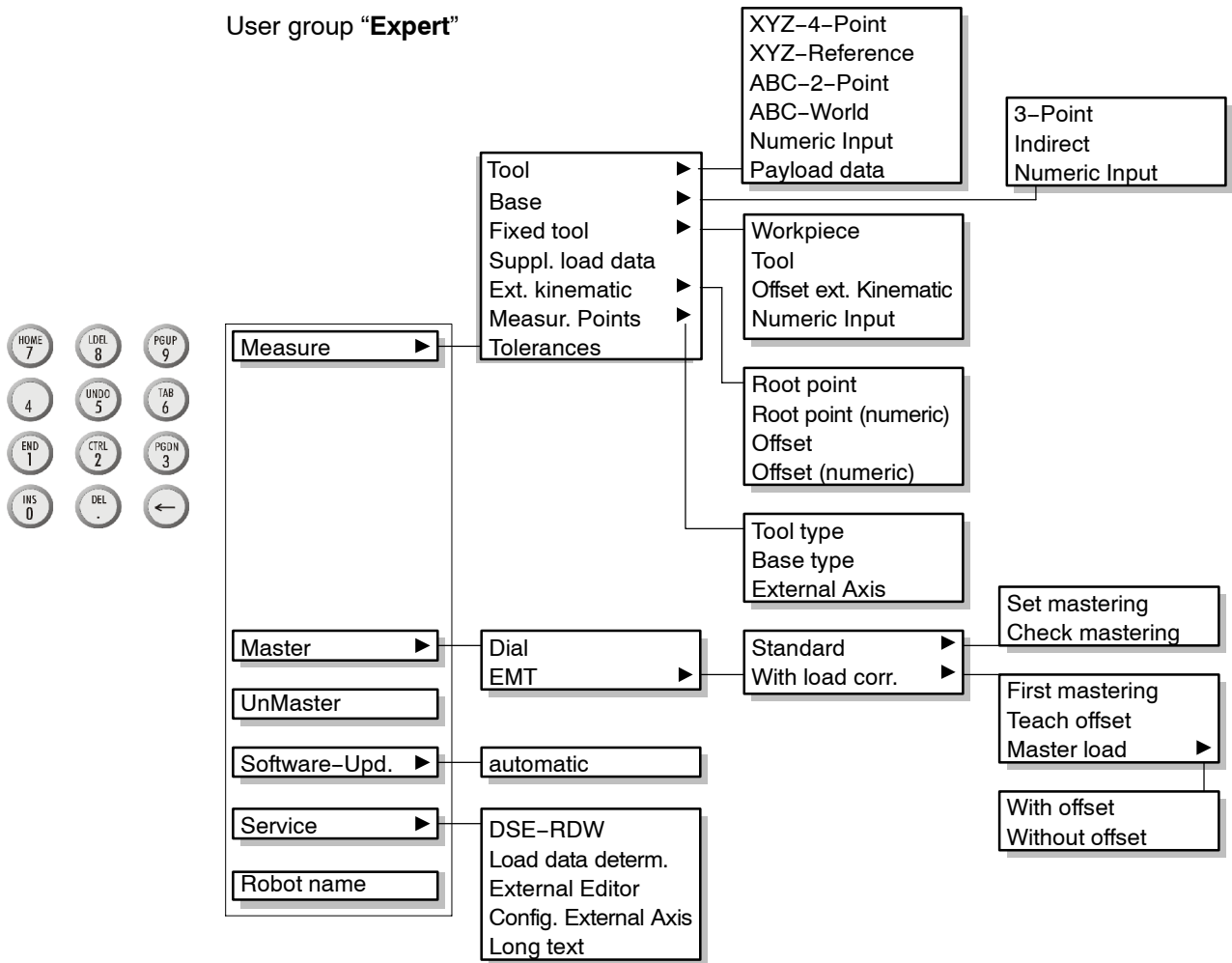



User group "User"

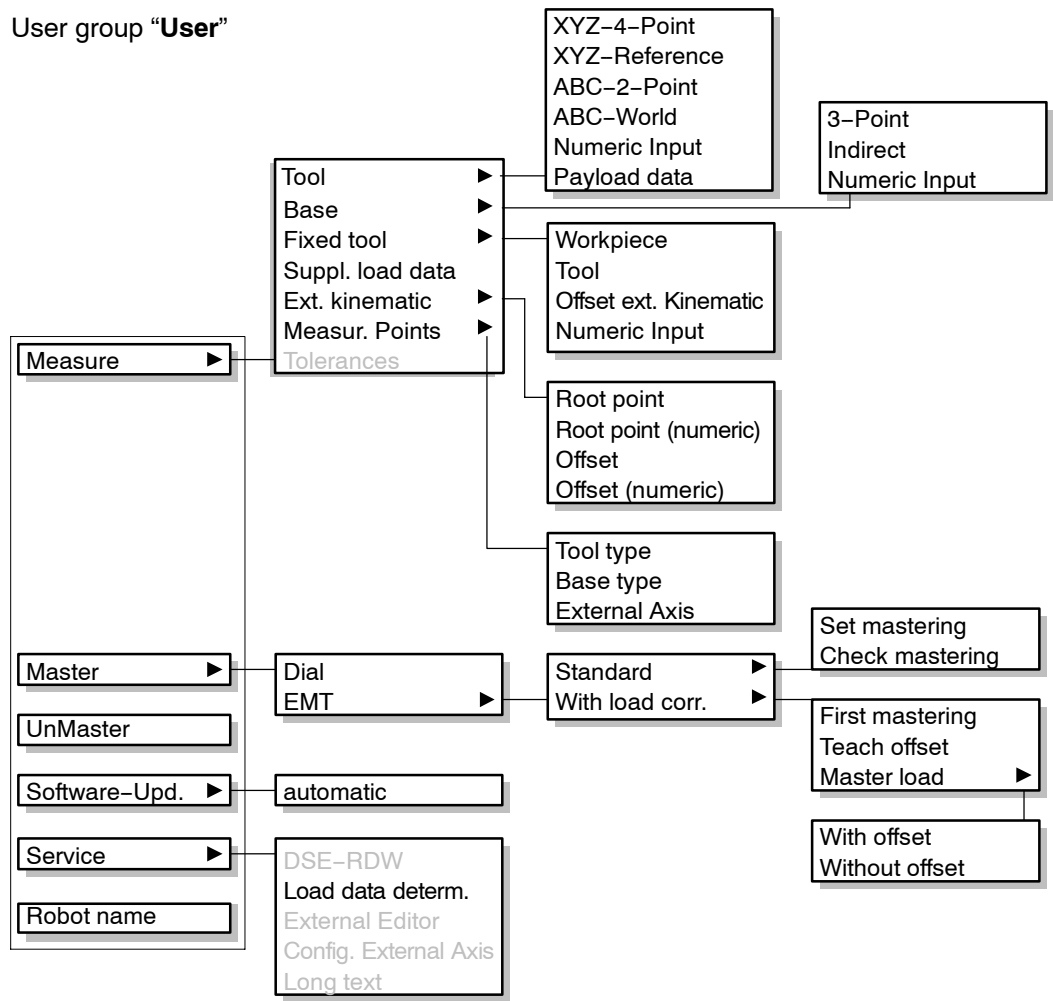

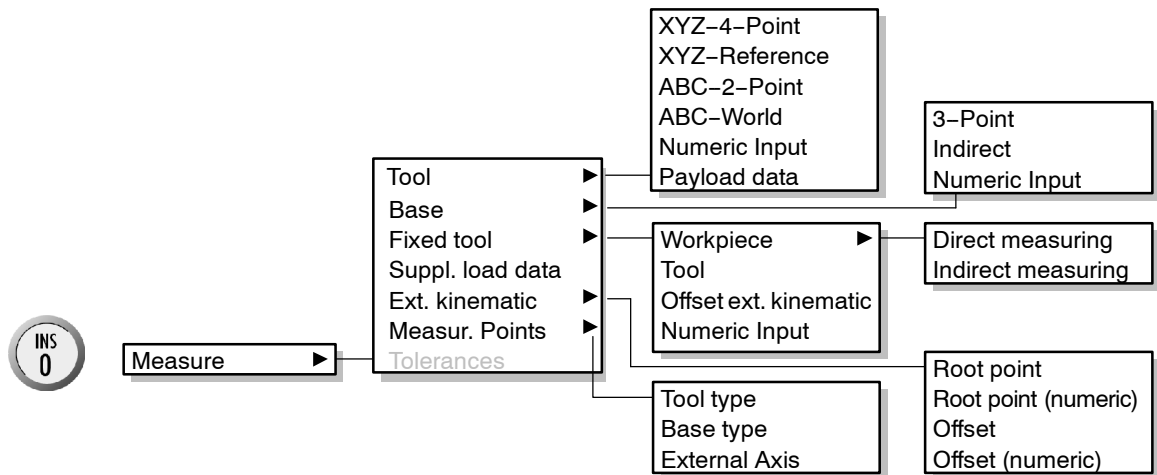

Measure	
<p>» Tool Calibration programs for position, orientation and structural calculations for a tool mounted on the robot wrist.</p> <p>» XYZ-4-Point Moving the robot to a fixed reference point.</p> <p>» XYZ-Reference Moving the robot with a known reference tool to a reference point.</p> <p>» ABC-2-Point Moving the robot to 2 points with orientation data.</p> <p>» ABC-World Positioning perpendicular to the world coordinate system.</p> <p>» Numeric Input Entering the tool data.</p> <p>» Payload data Entering the mass, center of mass and mass moment of inertia.</p>	<p>MC [Start-up], Ch. [Calibration]</p>
<p>» Base Calibration programs to determine workpiece position and orientation.</p> <p>» 3-Point Moving to the reference point of a workpiece.</p> <p>» Indirect Entering the inaccessible reference point of a workpiece.</p> <p>» Numeric Input Entering a reference point manually.</p>	
<p>» Fixed tool Calibration programs to define an external fixed tool.</p> <p>» Workpiece Moving with a workpiece mounted on the robot flange.</p> <p>» Tool Moving the robot to a fixed tool.</p>	

<ul style="list-style-type: none"> » Offset external kinematic Moving the robot to a fixed tool on an external kinematic system. » Numeric Input Entering a fixed tool manually. 	MC [Start-up], Ch. [Calibration]
<ul style="list-style-type: none"> » Supplementary load data Entry of data for a supplementary load on the robot. 	
<ul style="list-style-type: none"> » External kinematic <ul style="list-style-type: none"> » Root point Moving the distance from the world coordinate system to the external kinematic system. » Root point (numeric) Entering the distance from the world coordinate system to the external kinematic system manually. » Offset Moving the distance from the external kinematic system to the workpiece. » Offset (numeric) Entering the distance from the external kinematic system to the workpiece manually. 	MC [Start-up], Ch. [Calibration - External kinematics]
<ul style="list-style-type: none"> » Measurement Points <ul style="list-style-type: none"> » Tool type Display saved calibration data for the tool type. » Base type Display saved calibration data for the base type. » External Axis Display saved calibration data for the external axes. 	MC [Start-up], Ch. [Calibration]
<ul style="list-style-type: none"> » Tolerances ¹⁾ Entry of tolerance limits for tool calibration. 	
<p>¹⁾ Not available in the user group "User".</p>	

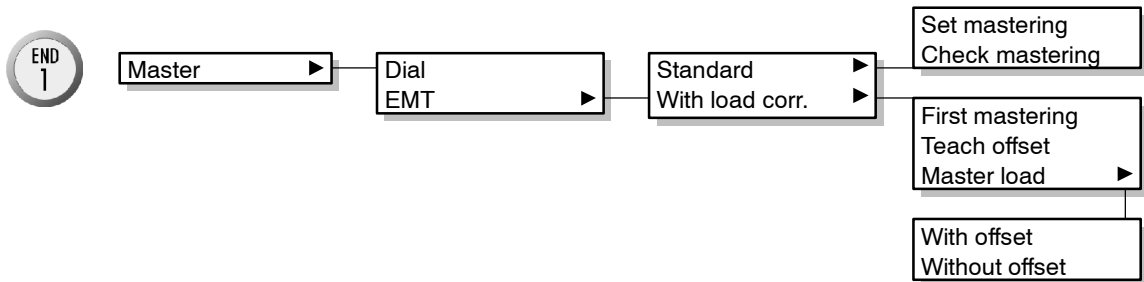

Master	
<ul style="list-style-type: none"> » Dial Mastering with a mechanical dial gauge. 	MC [Start-up], Ch. [Robot mastering / unmastering]

<p>» EMT Mastering with the electronic measuring tool.</p> <p>» Standard</p> <p>» Set mastering The robot is mastered in the mechanical zero position with or without a payload.</p> <p>» Check mastering Checks the mastering.</p> <p>» With load corr.</p> <p>» First mastering The robot is mastered in the mechanical zero position without a payload.</p> <p>» Teach offset The robot is mastered with a payload and the encoder offset relative to the first mastering is calculated for this payload.</p> <p>» Master load</p> <p>» With offset This function is used to check the mastering of a payload mounted on the robot, that has previously been mastered with "Teach offset".</p> <p>» Without offset Mastering of the robot with any load; the difference from the first mastering is calculated.</p>	<p>MC [Start-up], Ch. [Robot mastering / unmastering]</p>
--	--



UnMaster

Unmaster	
Unmastering of selected axes.	MC [Start-up], Ch. [Robot mastering / unmastering]



Software Upd. ▶ automatic

Software Update	
<p>» Automatic Load new version of program from CD-ROM.</p>	MC [Start-up], Ch. [Software Update]



Service ▶

- DSE-RDW
- Load data determ.
- External Editor
- Config.External Axis
- Long text

Service	
<p>» DSE - RDW ¹⁾ Displays for the "Digital Servo Electronics" and "Resolver-Digital Converter"</p>	HB Electrical Servicing

» Load data determination Determination of the load data	see additional package [Load data Determination]
» External Editor ¹⁾ External program for editing application programs at GUI and KRL levels.	HB Progr. Handbook MC [Expert Progr.] Ch. [External Editor]
» Config. External Axis ¹⁾ Setting up of external axes.	Separate documentation [External Axes]
» Long text ¹⁾ Names of inputs/outputs.	HB Progr. Handbook MC [Configuration] Ch. [Configuring the system]
1) Not available in the user group "User".	



Robot name

Robot name	
Changes the robot name.	MC [Start-up] Ch. [Robot name]

8.7 Commands

User group "Expert" and "User"

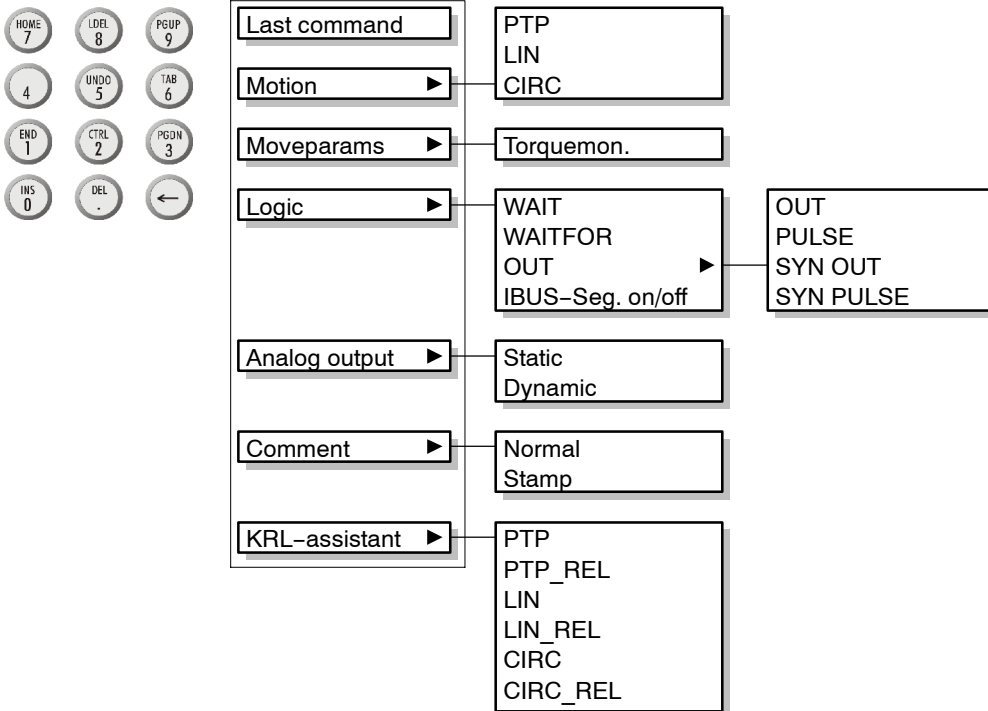

INS
0

Last command

Last command	
Repeats the last command executed.	MC [User programming] Ch. [Program commands]

END
1

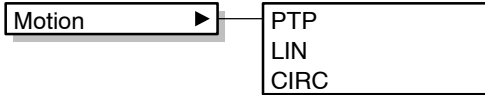

Motion	
» PTP Motion command "Point-to-Point". » LIN Motion command "Linear". » CIRC Motion command "Circular".	MC [User programming] Ch. [Program commands]

CTRL
2



Moveparams	
» Torquemon. Collision monitoring call.	MC [User programming] Ch. [Program commands]

PGDN
3

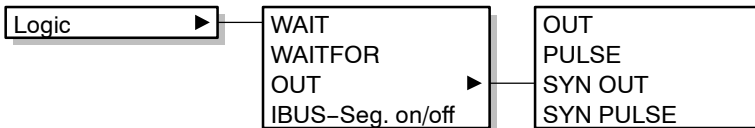

Logic	
» WAIT Time-dependent wait function.	MC [User programming] Ch. [Program commands]
» WAITFOR Signal-dependent wait function.	
» OUT » OUT Simple switching function. » PULSE Simple pulse function. » SYN OUT Path-dependent switching function. » SYN PULSE Path-dependent pulse function.	
» IBUS-Seg. on/off Coupling and decoupling an Interbus segment.	



4

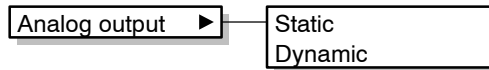

Analog output	
» Static Setting of analog outputs under program control to a fixed value.	MC [User programming] Ch. [Program commands]
» Dynamic Setting of analog outputs under program control to a fixed value that is dependent on the velocity or the specific technology package	

UNDO
5

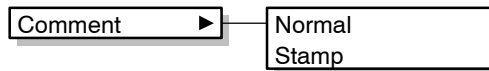

Comment	
» Normal Inserts a comment line into a program.	MC [User programming] Ch. [Program commands]
» Stamp Comment line with the date and time in a program.	

TAB
6

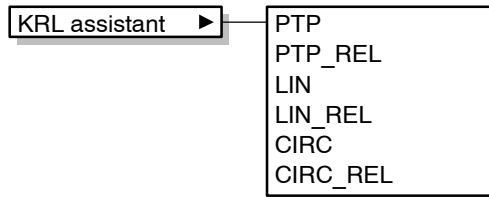

KRL assistant	
» PTP Absolute "point-to-point" motion.	MC [User programming] Ch. [Program commands]
» PTP_REL Relative "point-to-point" motion.	
» LIN Absolute linear motion.	
» LIN_REL Relative linear motion.	
» CIRC Absolute circular motion.	
» CIRC_REL Relative circular motion.	

8.8 Technology

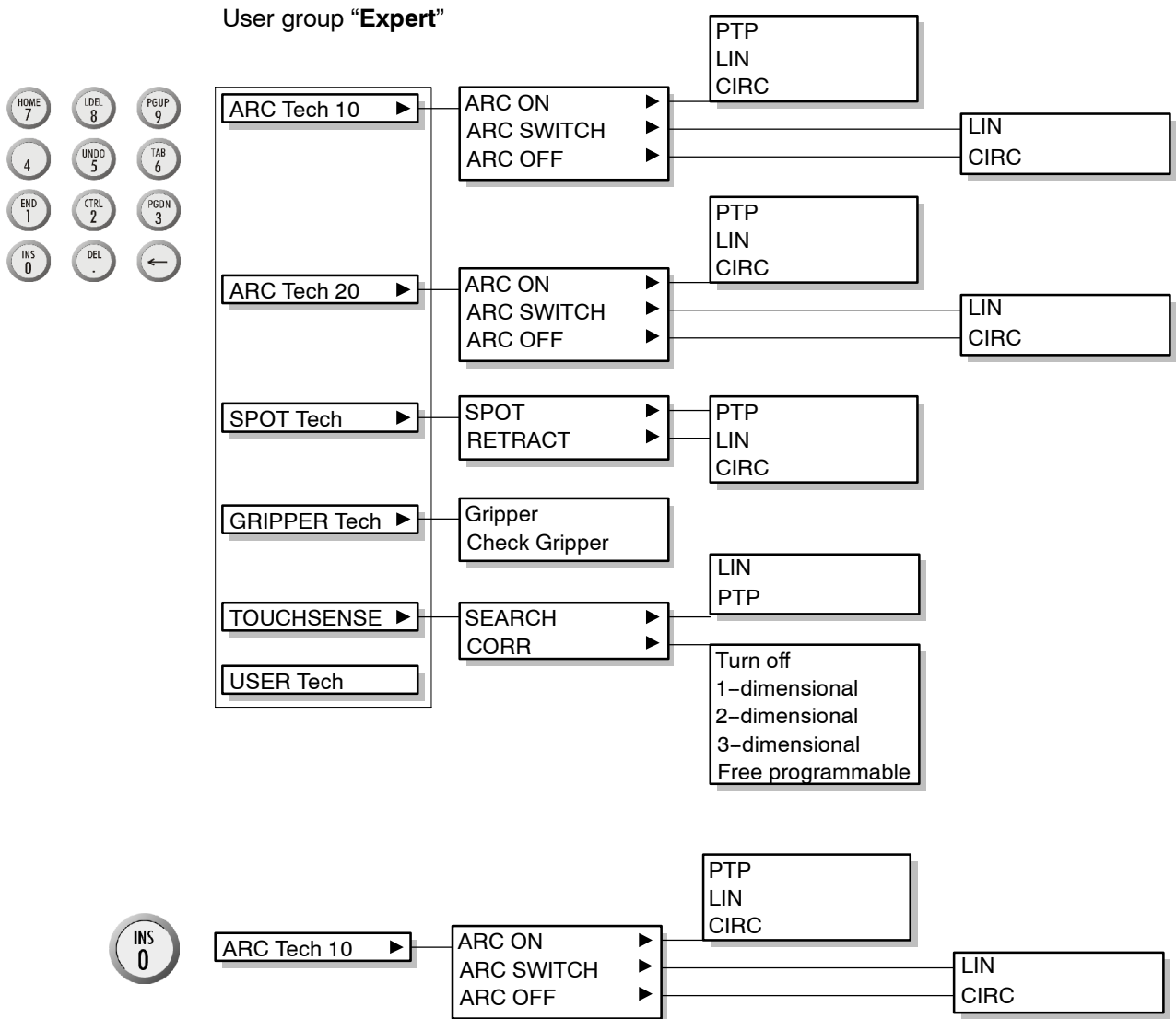

ARC Tech 10	
<ul style="list-style-type: none"> » ARC ON Start welding, including motion, start and ignition parameters. » PTP Point-to-point motion. » LIN Linear motion. » CIRC Circular motion. 	Additional documenta- tion Arc Welding [ArcTech 10]

<p>» ARC SWITCH Welding of several seam sections, including parameters for the seam section, and also for mechanical and thermal weaving.</p> <p>» LIN Linear motion.</p> <p>» CIRC Circular motion.</p>	<p>Additional documentation Arc Welding [ArcTech 10]</p>
<p>» ARC OFF Welding and ending a seam, including end parameters, crater filling, the gas postflow time and burnback.</p> <p>» LIN Linear motion.</p> <p>» CIRC Circular motion.</p>	

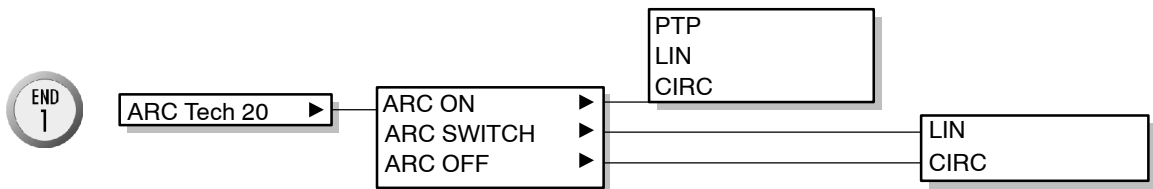

ARC Tech 20	
<p>» ARC ON Start welding, including motion parameters, program number for the power source and start delay.</p> <p>» PTP Point-to-point motion.</p> <p>» LIN Linear motion.</p> <p>» CIRC Circular motion.</p>	<p>Additional documentation Arc Welding [ArcTech 10]</p>
<p>» ARC SWITCH Welding of several seam sections, including parameters for the seam section, mechanical weaving.</p> <p>» LIN Linear motion.</p> <p>» CIRC Circular motion.</p>	
<p>» ARC OFF Welding and ending a seam, including motion parameters, program number for the power source, velocity and weave pattern, as well as crater filling.</p> <p>» LIN Linear motion.</p> <p>» CIRC Circular motion.</p>	

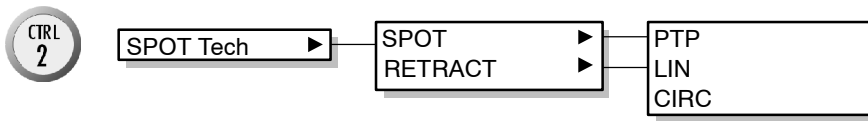

SPOT Tech	
» SPOT Moves the robot to a weld spot, opens and closes the welding gun. <ul style="list-style-type: none"> » PTP Point-to-point motion. » LIN Linear motion. » CIRC Circular motion. 	Additional documentation Spot Welding [SPOT Tech 10]
» RETRACT Moves the robot to a weld spot, opens and closes the welding gun. <ul style="list-style-type: none"> » PTP Point-to-point motion. » LIN Linear motion. » CIRC Circular motion. 	

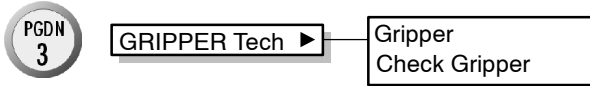

GRIPPER Tech	
» Gripper Programming gripper functions.	Additional documentation [Gripper Tech]
» Check Gripper Interrogations of any sensors fitted on the gripper.	

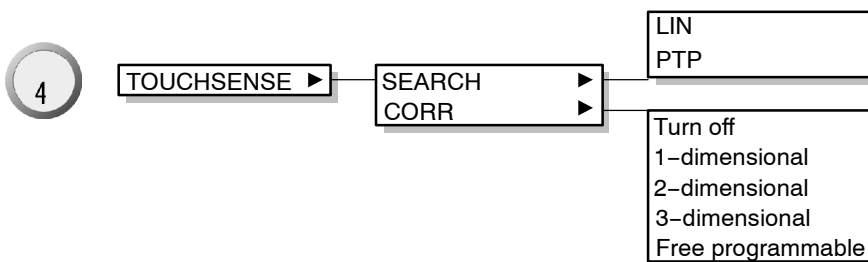

TOUCHSENSE	
» SEARCH Programming a search motion. <ul style="list-style-type: none"> » LIN Linear motion » PTP Point-to-point motion 	Additional documentation [Touch-Sensor]

<ul style="list-style-type: none"> » CORR Programming a correction instruction. » Turn off » 1-dimensional » 2-dimensional » 3-dimensional » Free programmable 	Additional documentation [Touch-Sensor]
--	---



USER Tech

USER Tech	
Programmable inline forms, status keys and scripts.	MC [Additional Functions] Ch. [UserTech]

8.9 Help



User groups “Expert” and “User”

Online help
Contents/Index
Info



Online help

Online help	
Starts context-specific online help for the topic currently selected.	MC [Operator Control], Ch. [Monitor]



Contents/Index

Online help – Contents/Index	
Overall index of the online help function.	MC [Operator Control], Ch. [Monitor]



Info

Version	
Provides version information (GUI / kernel system / system data)	MC [Operator Control], Ch. [Monitor]

Symbols

"Edit" menu, 112
\$LAST_BUFFERING_NOTOK, 21
\$PERI_RDY, 16
\$POWER_FAIL, 15
\$PRO_IP, 175
\$STOPMESS, 15, 16
*.DAT, 196

Numbers

3-Point, 215

A

ABC-2-Point, 215
ABC-World, 215
ALT key, 36
Alt-Escape, 46
Alt-Tab, 45
Analog output, 220
Analog Outputs, 148, 210
Archive, 102, 196
Arrow keys, 33
Attributes, 87, 111, 198
Attributes display, 76, 80
Aut, 44
Automatic, 55, 146
Automatic External, 55, 151, 206
Automatic external, 210
Automatic program execution, 139
Axis specific, 210

B

Backspace key, 35
Backwards key, 33
BASE, 49, 52
Base, 215
Base type, 207, 216
BCO run, 133, 139
Block coincidence, 133
Block pointer, 39, 43, 126
BOF reinitialization, 209
Braking ramp, 130
Brightness, 38

C

Cabinet lock, 10, 11

Caller Stack, 175, 211
Cancel program, 200, 202
Caps Lock, 36
Cartesian, 156, 210
CD-ROM drive, 10, 11
Change, 148, 165
Change password, 208
Check Gripper, 223
Check mastering, 217
CIRC, 219
Close, 204
COM1, 10
Commands, 194, 218
Comment, 96, 115, 220
Computer drives, 10, 11
Config. External Axis, 218
ConfigMon.ini, 162
Configure, 194, 205
Continue, 150
Continuing a program, 139
Contrast, 38
Control cabinet, 9
Control ON, 10
Control-Escape, 46
Controller switched back on, 15
Coordinate system, 49, 59
Coordinate systems TOOL, BASE, WORLD, 72
Copy, 113, 199, 203
Counter, 211
Counters, 194
CROSS Log book, 168, 174
Cross-Log book, 211
CTRL key, 35, 36
CTRL-Escape, 46
Cur. tool/base, 207
Current selection, 196
Current value, 160, 161
Cut, 114, 199, 204
Cyclic Flags, 211

D

Data list, 93
Def-line, 208
Degrees of freedom of the Space Mouse, 66
DEL key, 35
Delete, 93, 114, 200, 201, 204
Deselecting a program, 141

Detail view, 78
Detail view on/off, 208
Diagnosis, 104, 211
Dial, 216
Digital Inputs, 210
Digital Outputs, 210
Direction indicator, 127
Directory list, 76, 84
Directory structure, 76, 79
Disable PowerOff Delay, 208
Display, 194
Dominant axis, 69
Dominant axis activated, 70
Dominant axis not activated, 70
Driver Reset, 206
Drives, 76
Drives off, 30, 139
Drives on, 30
DSE – RDW, 217
Duplicate, 115, 200
Dynamic, 220
Dynamic braking, 131

E

Edit, 93, 98, 112
Edit Config., 206
Edit cursor, 127
Edit mode, 198
Editor, 208
EMERGENCY STOP button, 30
EMT, 217
Enabling switch, 33, 37, 150
Enabling switches, 62
END key, 35
Enter key, 33, 115
Error diagnosis, 89
Error display, 89
Error list, 89
Errorlist, 196
Escape key, 32
Executing program lines, 135
Executing, stopping and resetting a program, 125
Expert level, 79
Expert user group, 168
Ext, 44
External axes, 58
External Axis, 207, 216

External kinematic, 52, 216
External kinematic systems, 58
Externer Editor, 217

F

File, 94, 194, 195, 196
File attributes, 87
File list, 76, 84
File manager, 75
"File" menu, 94
File name, 87
File operations, 194
Filter, 78, 82, 111, 198
Find, 201, 204
First mastering, 217
Fixed tool, 215
Flags, 211
Floppy disk drive, 10, 11
Fold, 201, 203
Folder, 196
Force cold Startup, 208
Format floppy disk, 110, 198

G

Go, 132
Graphical user interface, 76
Gripper, 150, 206, 210, 223
GUI, 38

H

Header, 76, 78
Help, 180, 194, 224
HOME key, 35
HOV, 44

I

I-Step, 132
I/O Driver, 206
I/O Reconfigure, 206
IBUS-Seg., 219
Icon, 128
Icons, 76
In/Outputs, 206
Incremental, 158, 210
Incremental manual traversing, 73
Incremental Step, 132
Increments, 158

Indirect, 215
Info, 189
Inline form, 40
Input mark, 127
Inputs, 146
Inputs/Outputs, 210
Inputs/outputs, 143
INS key, 35
Interrupts, 211

J

Jog mode, 44, 55, 132
Jog OV steps, 61
Jog override, 44, 61, 207
Jog-OV-Steps on/off, 207
Jogging, 207
Joint, 49, 157
Joint coordinate system, 71
jump to, 90

K

KCP, 29
KCP connection, 12
KCP front, 29
KCP rear, 37
Keyboard, 36
KRL Assistant, 194
KRL assistant, 220
KUKA-Cross, 174

L

Language, 208
Last command, 219
LDEL key, 35
LIN, 219
Line breaks, 127
Line/column, 128
Linebreak on/off, 208
Load corr., 217
Load data determination, 217
Log book, 168, 169, 196, 211
Log Data, 104
Logic, 219
Logic commands, 194
Long text, 218
LPT1, 10

M

Main axes, 67
Main switch, 10, 11
Manual gripper operation, 150
Manual mode, 44
Manual program execution, 132
Manual traversing, 49, 57
Manual traversing of the robot, 55
Mark all, 199
Master, 216
Master load, 217
Master/Slave, 210
Master/slave display, 159
Maximum braking, 130
Measure, 215
Measurement Points, 216
Menu, 193
Menu bar, 38, 193
Menu key, 193
Menu keys, 34
Message window, 40
Messages in the status bar, 43
Miscellaneous, 208
Mode selector switch, 31, 55
Modify, 202
Modul info, 81
Module, 161
Modules, 78
Monitor, 119, 143, 194, 209
"Monitor" menu, 119
Monitoring working envelope, 208
Motion, 219
Motion commands, 194
Mouse configuration, 66, 69, 207
Mouse position, 63, 207
Moveparams, 219

N

Name, 115, 160, 165
Navigator, 75
New, 83, 95, 196
New Value, 160
Notices, 164, 211
NUM, 43, 80
NUM key, 35
Numeric Input, 215, 216
Numeric keypad, 35

O

Office GUI on/off, 208
Offset, 216
Offset external kinematic, 216
On/Off options, 208
On/off switch, 12
Online help, 180, 184, 224
Open, 196
Operating mode, 44
Operator control elements, 10, 30
Oscilloscope, 168, 211
OUT, 219
Outputs, 144

P

Page +, 171
Page -, 171
Parameter, 200
Parameters, 116
Paste, 113, 199, 203
Path-maintaining braking in event of operator safety violation, 131
Path-maintaining Emergency Stop, 130
Payload data, 215
PGDN key, 35
PGUP key, 35
Points in TTS, 202
Position, 194
POV, 44
Power failure, 15
Power OFF function, 14
Previous, 150
Print, 100, 196
Process pointer, 175
Program, 194, 199
Program creation, 194
Program name, 128
Program OV steps, 129
Program override, 44, 129, 207
Program pointer, 126
Program run mode, 132
Program start backwards, 132, 136
Program start backwards key, 33
Program start forwards key, 32, 37
Program stop key, 32
Program window, 39, 126
Program-OV-Steps on/off, 207

PTP, 219, 220

PULSE, 219

R

Ramp-down braking, 130
Reduced velocity, 150
Reference coordinate system, 59
Refresh, 171
Reinitialization, 209
Releasing EMERGENCY STOP, 30
Rename, 109, 197
Replace, 204
Reset, 12, 137
Reset program, 200, 202
Resetting a program, 137
Restore, 105, 197
Return key, 33
Reverse traversing, 132
Rob. Position, 156
Rob. position, 210
Robot name, 218
Root point, 216
Running up the controller, 9, 13

S

Safety circuit, 168
Safety instructions, 131
Security circuit, 211
Securitycircuit, 168
Select, 116, 125, 200
Selecting the kinematic system, 58
Selection list, 76, 82
Service, 217
Set mastering, 217
Setup, 194, 213
Shift key, 36
Short-circuit braking, 131
Shutting down the controller, 9, 14
Signal states, 144, 146
Simultaneous motion, 50
Single Step, 132
Skeleton program, 97, 98, 116
Softkey bar, 39
Softkeys, 35, 150
Software limit switches, 56
Software Update, 217
Space Mouse, 34, 49, 57, 62
Stamp, 220

START key, 32
Static, 220
Status bar, 41, 43
Status key bar, 38
Status keys, 34, 150
Status LED, 10
Status line, 41, 55, 76, 88, 128
Status window, 39, 57, 150
Statuskeys, 206
STOP key, 32
Stopping program execution, 137, 139
SUBMIT Interpreter, 206
Superposed motion, 70
Supplementary load data, 216
SYM key, 36
Symbols, 76
Symbols in the program window, 126
SYN OUT, 219
SYN PULSE, 219
System time, 44

T

T1, 44, 55
T2, 44, 55
TAB key, 35
Teach offset, 217
Technology, 194, 221
Technology commands, 194
Technology selection, 208
Templates, 83
Timer, 211
Toggling to the Windows interface, 45
Tolerances, 216
TOOL, 49
Tool, 53, 215
Tool definition, 207
Tool type, 207, 216
Torquemon, 219
Traversing keys, 49, 57, 71
Traversing mode, 38, 49, 57

U

UNDO key, 35
Unmaster, 217
User data, 81
User group, 175, 177, 207
USER Tech reinitialize, 209

V

Variable, 161, 210
Variables, 194
Version, 224
Version information, 194
Virus protection, 22

W

WAIT, 219
WAITFOR, 219
Warning and safety instructions, 131
Web Diagnosis, 211
Web Diagnosis, 178
Window selection key, 32, 95
Windows, 212
Windows interface, 45
Windows mouse, 47
With offset, 217
Without offset, 217
Work cell, 51
Workpiece, 215
WORLD, 49

X

X axis, 53
XYZ-4 Point, 215
XYZ-Reference, 215